

**ASTER LEVEL 1
DATA PRODUCTS
SPECIFICATION
(GDS Version)
Version 1.3**

June 25, 2001

This page intentionally left blank.

ERSDAC
Earth Remote Sensing
Data Analysis Center

**ASTER LEVEL 1
DATA PRODUCTS
SPECIFICATION
(GDS Version)
Version 1.3**

Approved by:

Dawn Lowe
ESDIS Project Manager
GSFC - Code 423

Date

Masami Hato
Project Manager
ASTER Ground Data System

Date

Revision History

No.	Title	Rev.	Date
1	ASTER Level 1 Data Products Specification (AG-E-E-2076-R00)	Ver. β	Oct. 18, 1996
2	ASTER Level 1 Data Products Specification (AG-E-E-2209-R00)	Ver. 1.0	Jun. 30, 1997
3	ASTER Level 1 Data Products Specification (AG-E-E-2209-R01)	Ver. 1.1	Nov. 10, 1997
4	ASTER Level 1 Data Products Specification (AG-E-E-2209-R02)	Ver. 1.2	Jul. 24, 1998
5	ASTER Level 1 Data Products Specification (AG-E-E-2209-R03)	Ver. 1.3	Jun. 25, 2001
6	ASTER Level 1 Data Products Specification (AG-E-E-2209-R03) (Signature page added and reference documents updated in section 1.1.2. This document was revalidated and will expire five years from the last signature date.)	Ver. 1.3	Jun. 25, 2001

Change Details-1 (1/6)

(Ver. β ⇒ Ver. 1.0)

Update Comments (based on Ver. β)		Ver. β	Ver. 1.0
2.2 Data Structure			
<ul style="list-style-type: none"> - Radiometric correction table is inserted into the Swath that we create. - Browse data is deleted from this document. 			
chg.	2.2 Data Structure: Figure 2.2-1	p.2-2	p.2-2
2.3.1.1 Inventory Metadata			
<ul style="list-style-type: none"> - Inventory Metadata of Level 1A Data Product has modified based on the concept of “Unified” Inventory Metadata for all ASTER products and related requirements. - ‘ProductionDateTime’ is added on account of Toolkit MET Tool's update. 			
del.	The objects described in Italics	Item 12 ~ 14	—
add.	ShortName	—	Item 1
add.	ProductionDateTime	—	Item 3
2.3.1.2 ASTER GDS Generic Metadata			
<ul style="list-style-type: none"> - This title has been changed to “ASTER Generic Metadata”. - ASTER GDS Generic Metadata of Level 1A Data Product has modified based on the concept of “Unified” ASTER Generic Metadata for all ASTER products and related requirements. 			
chg.	2.3.1.2 ASTER GDS Generic Metadata: changed the title name to ASTER Generic Metadata	p.2-5	p.2-5
del.	Several objects described in Italics	Item 11.2, 12.3, 13	—
chg.	Several objects described in Italics	Item 12.1 ~ 2	Item 10.7 ~ 8
mv.	GenerationDateandTime	Item 4	Inventory metadata
add.	Scene Orientation Angle	—	Item 10.9
2.3.1.3 GDS Generic Metadata:			
<ul style="list-style-type: none"> - GDS Generic Metadata is newly added to reflect the discussion results in the ASTER Science Team (in consideration). 			
2.3.1.3 Product Specific Metadata(VNIR)			
<ul style="list-style-type: none"> - HDF file attribute name is changed on account of Toolkit's update. - Descriptions of some items in Product Specific Metadata(VNIR) have been modified to reflect the discussion results in the ASTER Science Team. (x = 1 ~ 4) - The description of items concerning VNIR Band-2 is omitted on account that these items are created in the same manner (similar to VNIR Band-1). 			
chg.	Geometric Correction: Number of lattice point is revised.	Item x.3	Item x.3
chg.	Number of Bad Pixels: The elements of this Item are rewritten to match with those of SWIR and TIR.	Item x.5.1	Item x.5.1
del.	List of Bad Pixels: Separated this group from this attribute for flexibility and convenience of storing.	Item x.5.2	—
chg.	Unit Conversion Coefficients: Offset value is revised, and 2 other parameters are deleted.	Item x.6	Item x.6
add.	Destripe Parameter	—	Item x.7, 4.8
2.3.1.4 Product Specific Metadata(SWIR)			
<ul style="list-style-type: none"> - HDF file attribute name is changed on account of Toolkit's update. - Descriptions of some items in Product Specific Metadata(SWIR) have been modified to reflect the discussion results in the ASTER Science Team. (x = 1 ~ 6) - The descriptions of items concerning SWIR Band-5,6,7,8,9 are omitted on account that these items are created in the same manner (similar to SWIR Band-4). 			
chg.	Geometric Correction: Number of lattice point is revised.	Item x.3	Item x.3
del.	List of Bad Pixels: Separated this group from this attribute for flexibility and convenience of storing.	Item x.5.2	—
chg.	Unit Conversion Coefficients: Offset value is revised, and 2 other parameters are deleted.	Item x.6	Item x.6
add.	Destripe Parameter	—	Item x.7, 4.8

Change Details-1 (2/6)

(Ver. β ⇒ Ver. 1.0)

Update Comments (based on Ver. β)		Ver. β	Ver. 1.0
2.3.1.5 Product Specific Metadata(TIR)			
<ul style="list-style-type: none"> - HDF file attribute name is changed on account of Toolkit's update. - Descriptions of some items in Product Specific Metadata(TIR) have been modified to reflect the discussion results in the ASTER Science Team. (x = 1 ~ 5) - The descriptions of items concerning TIR Band-11,12,13,14 are omitted on account that these items are created in the same manner (similar to TIR Band-10). 			
chg.	Image Data Information: TIR pixel numbers are revised.	Item x.2	Item x.2
chg.	Geometric Correction: Number of lattice point is revised.	Item x.3	Item x.3
del.	List of Bad Pixels: Separated this group from this attribute for flexibility and convenience of storing.	Item x.5.2	—
chg.	Unit Conversion Coefficients: Offset value is revised, and 2 other parameters are deleted.	Item x.6	Item x.6
add.	Destripe Parameter	—	Item x.7, 4.8
add.	TIR Short Term Calibration Information	—	Item 8
2.3.1.7 Bad Pixel Information			
<ul style="list-style-type: none"> - Product specific attributes 'List of Bad Pixel' for all processed bands are divided from Product Specific metadata(VNIR, SWIR, TIR) and stored as a new data object. 			
2.3.2 Cloud Coverage Table			
<ul style="list-style-type: none"> - Evaluation area sizes of Table 2.3.3-1 and number of items in Cloud Coverage Table are modified. 			
chg.	Table 2.3.3-1: Dimension size is revised.	p.2-47	p.2-29
chg.	Note 2: Evaluation area size is revised.	p.2-47	p.2-29
2.3.3 Ancillary Data			
<ul style="list-style-type: none"> - Ancillary data volumes are revised in Table 2.3.3-1. 			
chg.	"Relative Scan Number" changed to "Time Tag".	Table 2.3.3-1	Table 2.3.3-1
chg.	"Note" changed to "Note 1".	p.2-49	p.2-30
add.	"Note 2" (descriptions about spacecraft time format)	—	Note 2
2.3.4.1 Overview			
<ul style="list-style-type: none"> - Vgroup name and class are changed to VNIR and 1A, respectively. 			
chg.	vgroup name: VNIR_Group is changed to VNIR.	p.2-50	p.2-32
add.	vgroup class: 1A (processing level)	—	p.2-32
2.3.4.2 VNIR Band 1 Swath			
<ul style="list-style-type: none"> - New data field 'RadiometricCorrTable' is added to Table 2.3.4-1 and 2.3.4-2. 			
chg.	Dimension Size of each filed: Number of lattice point is revised	Table 2.3.4-2	Table 2.3.4-2
chg.	Observation Time: Rewritten to match with CCSDS Day Segmented Time Code.	Table 2.3.4-2	Table 2.3.4-2
add.	Radiometric correction table	—	Table 2.3.4-1,2
2.3.4.3 VNIR Band 2 Swath			
2.3.4.4 VNIR Band 3N Swath			
<ul style="list-style-type: none"> - The descriptions of these objects are omitted on account that these objects are created in the same manner (similar to VNIR Band 1 Swath). 			
2.3.4.5 VNIR Band 3B Swath			
<ul style="list-style-type: none"> - New data type 'RadiometricCorrTable' is added to Table 2.3.4-3. 			
chg.	Dimension Size of each filed: Number of lattice point is revised	Table 2.3.4-3	Table 2.3.4-3
chg.	Observation Time: Rewritten to match with CCSDS Day Segmented Time Code.	Table 2.3.4-3	Table 2.3.4-3
add.	Radiometric correction table	—	Table 2.3.4-3
2.3.4.6 Radiometric Correction Table			
<ul style="list-style-type: none"> - These objects are deleted from Level 1A Data Product to reflect the changing data type. 			

Change Details-1 (3/6)

(Ver. β ⇒ Ver. 1.0)

Update Comments (based on Ver. β)		Ver. β	Ver. 1.0
2.3.4.7 VNIR Supplement Data			
- This Data type has been changed because of the rearrangement of Level 1A Data Product concept.			
chg.	Data model: data type is revised.	p.2-56	p.2-38
add.	Dimension Size: Record size is added as nominal value.	—	p.2-38
chg.	“Relative Scan Number” changed to “Time Tag”.	Table 2.3.4-9	Table 2.3.4-4
2.3.4.8 VNIR Browse Image			
- Browse data is deleted from this document based on the separation of Level 1A Product and Browse Data.			
2.3.5.1 Overview			
- Vgroup name and class are changed to SWIR and 1A, respectively.			
chg.	vgroup name: SWIR_Group is changed to SWIR.	p.2-59	p.2-40
add.	vgroup class: 1A (processing level)	—	p.2-40
2.3.5.2 SWIR Band 4 Swath			
- New data field ‘RadiometricCorrTable’ is added to Table 2.3.5-1 and 2.3.5-2.			
chg.	Dimension Size of each filed: Number of lattice point is revised	Table 2.3.5-2	Table 2.3.5-2
chg.	Observation Time: Rewritten to match with CCSDS Day Segmented Time Code.	Table 2.3.5-2	Table 2.3.5-2
add.	Radiometric correction table	—	Table 2.3.5-2
2.3.5.3 SWIR Band 5 Swath			
2.3.5.4 SWIR Band 6 Swath			
2.3.5.5 SWIR Band 7 Swath			
2.3.5.6 SWIR Band 8 Swath			
2.3.5.7 SWIR Band 9 Swath			
- The descriptions of these objects are omitted on account that these objects are created in the same manner (similar to SWIR Band 4 Swath).			
2.3.5.8 Radiometric Correction Table			
- These objects are deleted from Level 1A Data Product to reflect the changing data type.			
2.3.5.9 SWIR Supplement Data			
- Supplement data volumes are revised.			
- This Data type has been changed because of the rearrangement of Level 1A Data Product concept.			
chg.	Data model: data type is revised.	p.2-73	p.2-47
add.	Dimension Size: Record size is added as nominal value.	—	p.2-47
chg.	“Relative Scan Number” changed to “Time Tag”.	Table 2.3.5-14	Table 2.3.5-4
2.3.5.10 SWIR Browse Image			
- Browse data is deleted from this document based on the separation of Level 1A Product and Browse Data.			
2.3.6.1 Overview			
- Vgroup name and class are changed to TIR and 1A, respectively.			
chg.	vgroup name: TIR_Group is changed to TIR.	p.2-80	p.2-53
add.	vgroup class: 1A (processing level)	—	p.2-53
2.3.6.2 TIR Band 10 Swath			
- New data field ‘RadiometricCorrTable’ is added to Table 2.3.6-1 and 2.3.6-2.			
chg.	Dimension Size of each filed: Number of lattice point is revised	Table 2.3.6-2	Table 2.3.6-2
chg.	Observation Time: Rewritten to match with CCSDS Day Segmented Time Code.	Table 2.3.6-2	Table 2.3.6-2
chg.	Dimension Size of Image Data: TIR pixel number is revised.	Table 2.3.6-2	Table 2.3.6-2
add.	Radiometric correction table	—	

Change Details-1 (4/6)

(Ver. β ⇒ Ver. 1.0)

Update Comments (based on Ver. β)	Ver. β	Ver. 1.0
2.3.6.3 TIR Band 11 Swath 2.3.6.4 TIR Band 12 Swath 2.3.6.5 TIR Band 13 Swath 2.3.6.6 TIR Band 14 Swath - The descriptions of these objects are omitted on account that these objects are created in the same manner (similar to TIR Band 10 Swath).		
2.3.6.7 Radiometric Correction Table - These objects are deleted from Level 1A Data Product to reflect the changing data type.		
2.3.6.8 TIR Supplement Data - Supplement data volumes are revised. - This Data type has been changed because of the rearrangement of Level 1A Data Product concept.		
chg. Data model: data type is revised.	p.2-88	p.2-59
add. Dimension Size: Record size is added as nominal value.	—	p.2-59
chg. “Relative Scan Number” changed to “Time Tag”.	Table 2.3.6-11	Table 2.3.6-3
2.3.6.9 TIR Browse Image - Browse data is deleted from this document based on the separation of Level 1A Product and Browse Data.		
3.2 Data Structure - Data structure was reconstructed to reflect the discussion results in the ASTER Science Team. - New Data type ‘Geolocation Fields Data’ is added to Figure 3.2-1. - Ancillary and Supplement data are newly added to Level 1B Data Product.		
chg. 2.2 Data Structure: Figure 2.2-1	p.3-2	p.3-2
3.3.1.1 Inventory Metadata - Inventory Metadata of Level 1B Data Product has modified based on the concept of “Unified” Inventory Metadata for all ASTER products and related requirements. - ‘ProductionDateTime’ is added on account of Toolkit MET Tool's update.		
del. The objects described in Italics	Item 12 ~ 14	—
add. ShortName	—	Item 1
add. ProductionDateTime	—	Item 3
3.3.1.2 ASTER GDS Generic Metadata - This title has been changed to “ASTER Generic Metadata”. - ASTER GDS Generic Metadata of Level 1A Data Product has modified based on the concept of “Unified” ASTER Generic Metadata for all ASTER products and related requirements.		
chg. 2.3.1.2 ASTER GDS Generic Metadata: changed the title name to ASTER Generic Metadata	p.3-5	p.3-5
del. Several objects described in Italics	Item 11.2, 12.3, 13	—
chg. Several objects described in Italics	Item 12.1 ~ 2	Item 10.7 ~ 8
mv. GenerationDateandTime	Item 4	Inventory metadata
add. Scene Orientation Angle	—	Item 10.9
3.3.1.3 GDS Generic Metadata: - GDS Generic Metadata is newly added to reflect the discussion results in the ASTER Science Team (in consideration).		

Change Details-1 (5/6)

(Ver. $\beta \Rightarrow$ Ver. 1.0)

Update Comments (based on Ver. β)	Ver. β	Ver. 1.0	
3.3.1.3 Product Specific Metadata(VNIR) - HDF file attribute name is changed on account of Toolkit's update. - Descriptions of some items in Product Specific Metadata(VNIR) have been modified to reflect the discussion results in the ASTER Science Team. (x = 1 ~ 4) - The descriptions of items concerning VNIR Band-2,3N,3B are omitted on account that these items are created in the same manner (similar to VNIR Band-1).			
chg.	Image Statistics: Description is revised.	Item x.2	Item x.2
chg.	Number/List of Bad Pixels: Descriptions are revised.	Item x.3.1, 2	Item x.3.1
chg.	Processing Parameters: Descriptions are revised.	Item x.4	Item x.4
chg.	Unit Conversion Coefficients: Offset value is revised, and 2 other parameters are deleted.	Item x.5	Item x.5
3.3.1.4 Product Specific Metadata(SWIR) - HDF file attribute name is changed on account of Toolkit's update. - Descriptions of some items in Product Specific Metadata(SWIR) have been modified to reflect the discussion results in the ASTER Science Team. (x = 1 ~ 6) - The descriptions of items concerning SWIR Band-5,6,7,8,9 are omitted on account that these items are created in the same manner (similar to SWIR Band-4).			
chg.	Image Statistics: Description is revised.	Item x.2	Item x.2
chg.	Number/List of Bad Pixels: Descriptions are revised.	Item x.3.1, 2	Item x.3.1
chg.	Processing Parameters: Descriptions are revised.	Item x.4	Item x.4
chg.	Unit Conversion Coefficients: Offset value is revised, and 2 other parameters are deleted.	Item x.5	Item x.5
3.3.1.5 Product Specific Metadata(TIR) - HDF file attribute name is changed on account of Toolkit's update. - Descriptions of some items in Product Specific Metadata(TIR) have been modified to reflect the discussion results in the ASTER Science Team. (x = 1 ~ 5) - The descriptions of items concerning TIR Band-11,12,13,14 are omitted on account that these items are created in the same manner (similar to TIR Band-10).			
chg.	Image Statistics: Description is revised.	Item x.2	Item x.2
chg.	Number/List of Bad Pixels: Descriptions are revised.	Item x.3.1, 2	Item x.3.1
chg.	Processing Parameters: Descriptions are revised.	Item x.4	Item x.4
chg.	Unit Conversion Coefficients: Offset value is revised, and 2 other parameters are deleted.	Item x.5	Item x.5
3.3.1.7 Bad Pixel Information - Product specific attributes 'List of Bad Pixel' for all processed bands are divided from Product Specific metadata(VNIR, SWIR, TIR) and stored as a new data object.			
3.3.2 Ancillary Data - Ancillary data is added as a new data object 'Ancillary_Data'.			
3.3.2 VNIR Group - The contents of VNIR Group are modified to reflect the discussion results in the ASTER Science Team. - All image data are stored to only 1 Swath Object mapping with the newly added geolocation table.			
chg.	Map projection: Supported map projection is revised. (Mercator \rightarrow SOM)	p.3-51	p.3-21
chg.	vgroup name: VNIR_Group is changed to VNIR.	p.3-51	p.3-21
add.	vgroup class: 1B (processing level)	—	p.3-21
3.3.2.2 VNIR Band 1 Swath 3.3.2.3 VNIR Band 2 Swath 3.3.2.4 VNIR Band 3N Swath 3.3.2.5 VNIR Band 3B Swath - These objects are deleted on account that all images are stored to one swath at every subsystem.			
3.3.3.3 VNIR Supplement Data - VNIR Supplement data is added as a new data object 'VNIR Supplement'.			

Change Details-1 (6/6)

(Ver. β ⇒ Ver. 1.0)

Update Comments (based on Ver. β)	Ver. β	Ver. 1.0	
3.3.3 SWIR Group			
- The contents of SWIR Group are modified to reflect the discussion results in the ASTER Science Team.			
- All image data are stored to only 1 Swath Object mapping with the newly added geolocation table.			
chg.	vgroup name: SWIR_Group is changed to SWIR.	p.3-55	p.3-23
add.	vgroup class: 1B (processing level)	—	p.3-23
chg.	Dimension Size of geolocation fields: Number of lattice point is revised	Table 3.3.3-2, 4, 6, 8, 10, 12	Table 3.3.4-2
chg.	Block Size: Block Size is revised.	p.3-55, 56, 57, 58, 59, 60	p.3-23
3.3.3.2 SWIR Band 4 Swath			
3.3.3.3 SWIR Band 5 Swath			
3.3.3.4 SWIR Band 6 Swath			
3.3.3.5 SWIR Band 7 Swath			
3.3.3.6 SWIR Band 8 Swath			
3.3.3.7 SWIR Band 9 Swath			
- These objects are deleted on account that all images are stored to one swath at every subsystem.			
3.3.4.3 SWIR Supplement Data			
- SWIR Supplement data is added as a new data object 'SWIR_Supplement'.			
3.3.4 TIR Group			
- The contents of TIR Group are modified to reflect the discussion results in the ASTER Science Team.			
- All image data are stored to only 1 Swath Object mapping with the newly added geolocation table.			
chg.	vgroup name: TIR_Group is changed to TIR.	p.3-61	p.3-25
add.	vgroup class: 1B (processing level)	—	p.3-25
3.3.4.2 TIR Band 10 Swath			
3.3.4.3 TIR Band 11 Swath			
3.3.4.4 TIR Band 12 Swath			
3.3.4.5 TIR Band 13 Swath			
3.3.4.6 TIR Band 14 Swath			
- These objects are deleted on account that all images are stored to one swath at every subsystem.			
3.3.5.3 TIR Supplement Data			
- TIR Supplement data is added as a new data object 'TIR_Supplement'.			
Abbreviations and Acronyms			
- Abbreviations and Acronyms are refreshed.			
There are some additional corrected and modified parts that are hardly interpreted on account of the obscured expression.			

NOTES:

- add.: added item
- chg.: changed item
- del.: deleted item
- mv.: moved item

Change Details-2 (1/3)

(Ver. 1.0 ⇒ Ver. 1.1)

Update Comments (based on Ver. 1.0)	Ver. 1.0	Ver. 1.1	
1.1.1 Applicable Documents.			
- Some of the documents were revised, and the newest version of them apply to this specification.			
chg.	Algorithm Development Specification: ASTER Level-1 Data Processing	p.1-1	p.1-1
chg.	ASTER Level1 Data Products Specification	p.1-1	p.1-1
chg.	Interface Specification: ASTER Level-1 Data Processing	p.1-1	p.1-1
1.3 Time Code Format			
- The misprinting in the description about “decimal fraction of a second”(d→d), is corrected.			
- The description of the Spacecraft Time Format is slightly revised to remove the obscured expression.			
2.2 Data Structure			
- “Ancillary Group” is added to the figure of the data structure.			
add.	“Ancillary Group”	Figure 2.2-1	Figure 2.2-1
2.3.1.1 Inventory Metadata			
- The description of the “BoundingRectangle” is slightly changed to remove the obscured expression.			
- The description of the “SingleDateTime” is slightly changed to remove the obscured expression.			
chg.	BoundingRectangle	Item 6	Item 6
chg.	SingleDateTime	Item7	Item 7
2.3.1.2 ASTER Generic Metadata			
- The format information is added to the description of the “IDofASTERGDSDataGranule”.			
- The data stored in the elements of “SourceDataProduct” are changed. It is because “DataID” (Data ID) and “GenDT” (Generation Date and Time) of Level-0 data cannot be acquired by PGE during Level-1A generation, ‘N/A’'s are stored in those elements.			
chg.	IDofASTERGDSDataGranule	Item 1	Item 1
chg.	SourceDataProduct.	Item 8	Item 8
2.3.1.4 Product Specific Metadata(VNIR)			
- The nominal values for “GeometricCorrection” are corrected. In version 1.0, the nominal values in along-track direction and those in cross-track direction were described oppositely.			
- The data stored in the “ConUnit” of “UnitConversionCoeff”'s are added to the descriptions.			
- The descriptions and the objects are added to the “DestripeParameter”'s. (TBD in Ver. 1.0)			
- The nominal value of “Ncycles” of “FirstPixelAddressGroup” is changed to 10.			
chg.	GeometricCorrection1, 3N, 3B	Item 1.3, 3.3, 4.3	Item 1.3, 3.3, 4.3
chg.	UnitConversionCoeff1, 3N, 3B	Item 1.6, 3.6, 4.6	Item 1.6, 3.6, 4.6
chg.	DestripeParameter1, 3N, 3B	Item 1.7, 3.7, 4.8	Item 1.7, 3.7, 4.8
chg.	FirstPixelAddressGroup	Item 4.7	Item 4.7
2.3.1.5 Product Specific Metadata(SWIR)			
- The data stored in the “ConUnit” of “UnitConversionCoeff”'s are added to the descriptions.			
- The descriptions and the objects are added to the “DestripeParameter”'s. (TBD in Ver. 1.0)			
chg.	UnitConversionCoeff4	Item 1.6	Item 1.6
chg.	DestripeParameter4	Item 1.7	Item 1.7
2.3.1.6 Product Specific Metadata(TIR)			
- The data stored in the “ConUnit” of “UnitConversionCoeff”'s are added to the descriptions.			
- The descriptions and the objects are added to the “DestripeParameter”'s. (TBD in Ver. 1.0)			
chg.	UnitConversionCoeff10	Item 1.6	Item 1.6
chg.	DestripeParameter10	Item 1.7	Item 1.7
2.3.2 Cloud Coverage Table			
- The description of characteristics is modified to remove obscurity.			

Change Details-2 (2/3)

(Ver. 1.0 ⇒ Ver. 1.1)

Update Comments (based on Ver. 1.0)	Ver. 1.0	Ver. 1.1
2.3.3 Ancillary Data - The description about vgroup, which consists of Ancillary data records, is added. - The nominal record number is modified to reflect the discussion results with the ASTER Science Team. - The variable size of some field data is changed to store them correctly. - The resolution and range of “Attitude Rate” are corrected. - The range of “Solar Position” and “Moon Position” are changed to reflect the discussion results with the ASTER Science Team.		
chg. Variable Size of “Time_Conversion”	Table 2.3.3-1	Table 2.3.3-1
chg. Variable Size of “Position”	Table 2.3.3-1	Table 2.3.3-1
chg. Variable Size of “Velocity”	Table 2.3.3-1	Table 2.3.3-1
chg. Variable Size of “Attitude_Angle”	Table 2.3.3-1	Table 2.3.3-1
chg. Variable Size of “Attitude_Rate”	Table 2.3.3-1	Table 2.3.3-1
chg. Variable Size of “Magnetic_Coil”	Table 2.3.3-1	Table 2.3.3-1
2.3.4.6 VNIR Supplement Data - “TBD”s in the description of VNIR Supplement Data are changed to “Spare”, according to description in ATBD.		
chg. No. (Item number) 45 ~ 57	Table 2.3.4-4	Table 2.3.4-4
2.3.5.2 SWIR Band 4 Swath - Unit of “ParallaxOffset” is corrected to degree.		
chg. ParallaxOffset	Table 2.3.5-1	Table 2.3.5-1
2.3.5.8 SWIR Supplement Data - The misprints in the dimension size and in the nominal record count number are corrected. - The misprints in the item numbers in Table 2.3.5-4 are corrected.		
chg. No. (Item number) 12 ~ 49	Table 2.3.5-4	Table 2.3.5-4
2.3.6.7 TIR Supplement Data - The misprint in the nominal record count number is corrected. - The nominal record count number for Chopper and Encoder data is added.		
3.2 Data Structure - “Ancillary Group” is added to the figure of the data structure.		
add. “Ancillary Group”	Figure 3.2-1	Figure 3.2-1
3.3.1.2 ASTER Generic Metadata - The format information is added to the description of the “IDofASTERGDSDataGranule”. - The data stored in the elements of “SourceDataProduct” are changed. ‘N/A’ is stored in “DataTyp” (Data Type).		
chg. IDofASTERGDSDataGranule	Item 1	Item 1
chg. SourceDataProduct.	Item 8	Item 8
3.3.1.4 Product Specific Metadata(VNIR) - The data stored in the “ConUnit” of “UnitConversionCoeff”s are added to the descriptions.		
chg. UnitConversionCoeff1	Item 1.5	Item 1.5
3.3.1.5 Product Specific Metadata(SWIR) - The data stored in the “ConUnit” of “UnitConversionCoeff”s are added to the descriptions.		
chg. UnitConversionCoeff4	Item 1.5	Item 1.5
3.3.1.6 Product Specific Metadata(TIR) - The data stored in the “ConUnit” of “UnitConversionCoeff”s are added to the descriptions.		
chg. UnitConversionCoeff10	Item 1.5	Item 1.5

Change Details-2 (3/3)

(Ver. 1.0 ⇒ Ver. 1.1)

Update Comments (based on Ver. 1.0)	Ver. 1.0	Ver. 1.1
3.3.2 Ancillary Data <ul style="list-style-type: none">- The description about vgroup, which consists of Ancillary data records, is added.- The nominal record number is modified to reflect the discussion results with the ASTER Science Team.		
3.3.3.2 VNIR Swath <ul style="list-style-type: none">- “Dimension Size” of geolocation field is redesigned to reflect the discussion results with the ASTER Science Team.		
chg. Dimension Size of “Latitude” and “Longitude”	Table 3.3.3-2	Table 3.3.3-2
There are some additional corrected and modified parts that are hardly interpreted on account of the obscured expression.		

NOTES:

- add.: added item
- chg.: changed item
- del.: deleted item
- mv.: moved item

Change Details-3

(Ver. 1.1 ⇒ Ver. 1.2)

Update Comments (based on Ver. 1.1)	Ver. 1.1	Ver. 1.2	
1.1.1 Applicable Documents.			
- Some of the documents were revised, and the newest version of them apply to this specification.			
chg.	Algorithm Development Specification: ASTER Level-1 Data Processing	p.1-1	p.1-1
chg.	ASTER Level1 Data Products Specification	p.1-1	p.1-1
chg.	Interface Specification: ASTER Level-1 Data Processing	p.1-1	p.1-1
1.6 Map Projection Parameters			
- The descriptions of the map projection parameters are added.			
2.2 Data Structure			
- “Ancillary Group” is added to the figure of the data structure.			
add.	“Ancillary Group”	Figure 2.2-1	Figure 2.2-1
2.3.1.2 ASTER Generic Metadata			
- The data stored in the elements of “SourceDataProduct” are changed. It is because “DataID”.			
- The data stored.			
chg.	IDofASTERGDSDataGranule	Item 1	Item 1
chg.	SourceDataProduct.	Item 8	Item 8
2.3.1.4 Product Specific Metadata(VNIR)			
- The data stored in the “ConUnit” of “UnitConversionCoeff”s are added to the descriptions.			
chg.	GeometricCorrection1, 3N, 3B	Item 1.3	Item 1.3
chg.	UnitConversionCoeff1, 3N, 3B	Item 1.6	Item 1.6
2.3.1.5 Product Specific Metadata(SWIR)			
- The data stored in the “ConUnit” of “UnitConversionCoeff”s are added to the descriptions.			
chg.	DestripeParameter4	Item 1.7	Item 1.7
2.3.1.6 Product Specific Metadata(TIR)			
- The data stored in the “ConUnit” of “UnitConversionCoeff”s are added to the descriptions.			
chg.	DestripeParameter10	Item 1.7	Item 1.7
2.3.2 Cloud Coverage Table			
- The description of characteristics is modified to remove the ambiguous expressions.			
2.3.4.6 VNIR Supplement Data			
- “TBD”s in the description of VNIR Supplement Data are changed to “Spare”, according to description.			
chg.	No. (Item number) 45 ~ 57	Table 2.3.4-4	Table 2.3.4-4

NOTES:

- add.: added item
- chg.: changed item
- del.: deleted item
- mv.: moved item

Change Details-4

(Ver. 1.2 ⇒ Ver. 1.3)

Update Comments (based on Ver. 1.2)		Ver. 1.2	Ver. 1.3
2.3.1.2 ASTER Generic Metadata			
- The explanation of “SceneOrientationAngle” is modified.			
chg.	SceneOrientationAngle	Item 10.9	Item 10.9
2.3.1.4 Product Specific Metadata(VNIR)			
- Number of lines in frame for VNIR 3B is revised.			
- The nominal value for “GeometricCorrection3B” is modified.			
chg.	ImageDataInformation3B	Item 4.2	Item 4.2
chg.	GeometricCorrection3B	Item 4.3	Item 4.3
2.3.3 Ancillary Data			
- The nominal record count number is modified.			
2.3.4.2 VNIR Band 1 Swath			
- The coordinate system of “SatellitePosition” and “SatelliteVelocity” is revised.			
chg.	SatellitePosition	Item 6	Item 6
chg.	SatelliteVelocity	Item 7	Item 7
2.3.4.5 VNIR Band 3B Swath			
- Number of lines in frame for VNIR 3B is revised.			
chg.	Dimension Size of mapping to geolocation array : ImageData is modified.	Table 2.3.4-3	Table 2.3.4-3
chg.	Revised to accommodate a processing scene : nominal is modified.	Table 2.3.4-3	Table 2.3.4-3
2.3.4.6 VNIR Supplement Data			
- The nominal record count number is modified.			
2.3.5.2 SWIR Band 4 Swath			
- The coordinate system of “SatellitePosition” and “SatelliteVelocity” is revised.			
chg.	SatellitePosition	Item 9	Item 9
chg.	SatelliteVelocity	Item 10	Item 10
2.3.6.2 TIR Band 10 Swath			
- The coordinate system of “SatellitePosition” and “SatelliteVelocity” is revised.			
chg.	SatellitePosition	Item 7	Item 7
chg.	SatelliteVelocity	Item 8	Item 8
3.3.1.2 ASTER Generic Metadata			
- “SceneOrientationAngle” in the description of ASTER Generic Metadata is changed to “MapOrientationAngle”.			
chg.	MapOrientationAngle	Item 10.9	Item 10.9

NOTES:

- add.: added item
- chg.: changed item
- del.: deleted item
- mv.: moved item

PREFACE

This Specification defines Level-1A and 1B Data Products (L1PGE Version 04.00), which are generated from the software of ASTER Level-1 Data Processing Subsystem (Version 2.0).

ACKNOWLEDGMENT

The ASTER level-1 data product generation software needs the GTOPO30 in the processing subsystem. These data are distributed by the EROS Data Center Distributed Active Archive Center (EDC DAAC), located at the U.S. Geological Survey's EROS Data Center in Sioux Falls, South Dakota.

Table of Contents

1. Level 1 Overview-----	1
1.1 Applicable Standards-----	1
1.1.1 Applicable Documents-----	1
1.1.2 Reference Documents-----	1
1.2 Coordinates Systems-----	2
1.3 Time Code Formats-----	3
1.4 Data Type Definitions-----	4
1.5 Strip Observation Mode-----	5
1.6 Map Projection Parameters-----	7
2. Level 1A Data Product-----	1
2.1 Overview-----	1
2.2 Data Structure-----	1
2.3 Data Format-----	3
2.3.1 Metadata-----	3
2.3.1.1 Inventory Metadata-----	4
2.3.1.2 ASTER Generic Metadata-----	6
2.3.1.3 GDS Generic Metadata-----	11
2.3.1.4 Product Specific Metadata(VNIR)-----	12
2.3.1.5 Product Specific Metadata(SWIR)-----	20
2.3.1.6 Product Specific Metadata(TIR)-----	24
2.3.1.7 Bad Pixel Information-----	29
2.3.2 Cloud Coverage Table-----	32
2.3.3 Ancillary Data-----	33
2.3.4 VNIR Group-----	35
2.3.4.1 Overview-----	35
2.3.4.2 VNIR Band 1 Swath-----	35
2.3.4.3 VNIR Band 2 Swath-----	38
2.3.4.4 VNIR Band 3N Swath-----	39
2.3.4.5 VNIR Band 3B Swath-----	40
2.3.4.6 VNIR Supplement Data-----	41
2.3.5 SWIR Group-----	43
2.3.5.1 Overview-----	43
2.3.5.2 SWIR Band 4 Swath-----	43
2.3.5.3 SWIR Band 5 Swath-----	45
2.3.5.4 SWIR Band 6 Swath-----	46
2.3.5.5 SWIR Band 7 Swath-----	47
2.3.5.6 SWIR Band 8 Swath-----	48
2.3.5.7 SWIR Band 9 Swath-----	49
2.3.5.8 SWIR Supplement Data-----	50
2.3.6 TIR Group-----	56
2.3.6.1 Overview-----	56
2.3.6.2 TIR Band 10 Swath-----	56
2.3.6.3 TIR Band 11 Swath-----	58
2.3.6.4 TIR Band 12 Swath-----	59
2.3.6.5 TIR Band 13 Swath-----	60
2.3.6.6 TIR Band 14 Swath-----	61
2.3.6.7 TIR Supplement Data-----	62
3. Level 1B Data Product-----	1

3.1 Overview	1
3.2 Data Structure	1
3.3 Data Format	3
3.3.1 Metadata	3
3.3.1.1 Inventory Metadata	3
3.3.1.2 ASTER Generic Metadata	5
3.3.1.3 GDS Generic Metadata	10
3.3.1.4 Product Specific Metadata(VNIR)	11
3.3.1.5 Product Specific Metadata(SWIR)	13
3.3.1.6 Product Specific Metadata(TIR)	16
3.3.1.7 Bad Pixel Information	19
3.3.2 Ancillary Data	21
3.3.3 VNIR Group	22
3.3.3.1 Overview	22
3.3.3.2 VNIR Swath	23
3.3.3.3 VNIR Supplement Data	24
3.3.4 SWIR Group	25
3.3.4.1 Overview	25
3.3.4.2 SWIR Swath	25
3.3.4.3 SWIR Supplement Data	26
3.3.5 TIR Group	27
3.3.5.1 Overview	27
3.3.5.2 TIR Swath	27
3.3.5.3 TIR Supplement Data	28
Appendix A. Programming Model	1
A.1 Overview	1
A.2 Swath	1
Abbreviations and Acronyms	1

1. Level 1 Overview

1.1 Applicable Standards

This section identifies documents that directly apply in defining this interface specification, and those reference documents that indirectly apply to obtain background information related.

1.1.1 Applicable Documents

The following documents apply to this Specification in whole, unless cited otherwise herein.

- [1] ERSDAC-LEL/8-9 **Algorithm Theoretical Basis Document for ASTER Level-1 Data Processing (Ver.3.0)**, prepared by Level-1 Data Working Group, ASTER Science Team, Japan, Nov. 1, 1996
- [2] ERSDAC-LEL/9-16 **Algorithm Development Specification: ASTER Level-1 Data Processing (for Ver.2.2A)**, Mar. 31, 1998 (in Japanese)
- [3] ERSDAC-LEL/9-13 **ASTER Level 1 Data Products Specification (Science Version, Ver.2.4)**, June. 1, 2001
- [4] ERSDAC **Interface Specification: ASTER Level-1 Data Processing (for Ver.2.0+)**, Mar. 31, 1998 (in Japanese)
- [5] AG-S-E-0409-R03 **ASTER GDS Core Meta Data Specification (Version 1.0 Draft)**, Jul. 3, 1996

1.1.2 Reference Documents

The following documents are used as background reference documents related to this Specification.

- [1] 428-ICD-EDOS/ASTER **Interface Control Document between EDOS and ASTER GDS, CDRL B311**, Revision 4, March 1, 2005
- [2] CCSDS 641.0-B-2 **Parameter Value Language Specification (CCSD006 and CCSD0008)**, Blue Book, June 2000
- [3] CCSDS 301.0-B-3 **Time Code Formats**, Blue Book, Issue 3, January 2002
- [4] 170-EEB-001 **HDF-EOS Library User's Guide for the ECS Project, Volume 1: Overview and Examples**, July 2009
- [5] 170-EEB-002 **HDF-EOS Library User's Guide for the ECS Project, Volume 2: Function Reference Guide**, July 2009
- [6] none **HDF User's Guide Version 4.2.5**, The HDF Group, February 2010
- [7] 814-EEB-001 **SCF Toolkit 5.2.16 for the ECS Project**, July 2009
- [8] 311-EMD-220 **Release 7.22 INGEST Database Design Schema Specifications for the EMD Project, March 2009**
- [9] 311-EMD-224 **Release 7.22 Order Manager Database Design Schema Specifications for the EMD Project, March 2009**
- [10] 311-EMD-225 **Release 7.22 Spatial Subscription Server (SSS) Database Design Schema Specifications for the EMD Project, March 2009**
- [11] 311-EMD-226 **Release 7.22 Data Pool (DPL) Database Design Schema Specifications for the EMD Project, March 2009**
- [12] 311-EMD-227 **Release 7.22 Archive Management Inventory (AIM) Database Design Schema Specifications for the EMD Project, March 2009**
- [13] ERSDAC-LEL/9-18 **ASTER Browse Data Products Specification (Science Version, Version 2.1)**, Mar. 31, 1998
- [14] ERSDAC-LEL/7-5 **Interface Specification: ASTER Level-1 Data Processing (for Ver. α , Ver. β)**, 1994 (in Japanese)

1.2 Coordinates Systems

This section describes the definition of the following coordinates systems used in this specification;

- Spacecraft Reference Frame
- Orbital Reference Frame
- Earth-Centered Inertial Coordinates System
- Earth Greenwich Coordinates System

Note: Above all coordinates systems are a cartesian coordinates system, forming a right-handed coordinates system.

(1) Spacecraft Reference Frame

- attitude reference frame of spacecraft bus

[Origin]	Spacecraft Center of Mass
[Reference Direction]	X-axis : Roll axis
	Y-axis : Pitch axis
	Z-axis : Yaw axis

(3) Orbital Reference Frame

- reference frame of flight attitude on orbit

[Origin]	Spacecraft Center of Mass
[Reference Plane]	X-Y Plane : normal to the position vector
	Z-axis : directed toward geocentric nadir
[Reference Direction]	X-axis : the vector cross product between Z-axis and Y-axis that is normal to the orbit, anti-parallel to the angular momentum

(4) Earth-Centered Inertial Coordinates System (Mean Equator and Equinox of J2000)

[Origin]	Center of the Earth
[Reference Plane]	X-Y Plane : plane of Earth's mean equator
	Z-axis : along Earth's rotational axis, with north positive
[Reference Direction]	X-axis : directed toward the vernal equinox

(5) Earth Greenwich (Earth-Centered Rotating: ECR) Coordinates System

[Origin]	Center of the Earth
[Reference Plane]	X-Y Plane : plane of Earth's equator
	Z-axis : along Earth's rotational axis, with north positive
[Reference Direction]	X-axis : directed toward the prime (Greenwich) meridian

1.3 Time Code Formats

Time and Date described in Level 1A and 1B Data Products are expressed in two formats; CCSDS ASCII Time Code (A format) and Spacecraft Time Format (CCSDS Day Segmented Time Code: CDS). The time code formats can be represented as a combination of a preamble (P) field and a time (T) field. But the P-field is implied and not actually transmitted (i.e., this information is not included in these products).

Both time code formats are defined in CCSDS Blue Book, Issue 2, Time Code Formats, (CCSDS 301.0-B-2) issued by the Consultative Committee for Space Data Systems (NASA Code-OS, NASA, Washington DC 20546), April 1990.

(1) CCSDS ASCII Calendar Segmented Time Code (ASCII)

CCSDS ASCII segmented time code is composed of a variable number of ASCII characters forming the T-field. ASCII time code variations are UTC (Universal Time Coordinated) based and leap second corrections are made.

The format for ASCII Time Code A as used in ASTER Level-1 Data Processing Subsystem:

YYYY-MM-DDThh:mm:ssZ

or

YYYY-MM-DDThh:mm:ss.d...dZ

where,

- YYYY** : a four character subfield for year, with value in range 1970 ~ 2038
- MM** : a two character subfield for month with values 01 ~ 12, leading zeros
- DD** : a two character subfield for day with values in the range 01 ~ eom (where eom is 28, 29, 30, or 31 according to the month)
- T** : a separator
- hh** : a two character subfield for hours, with values 00 ~ 23
- mm** : a two character subfield for minutes, with values 00 ~ 59
- ss** : a two character subfield for seconds, with values 00 ~ 59 (00 ~ 60 in a positive leap second interval, 00 ~ 58 in the case of negative leap second)
- d→d** : an n-character subfield, ($n \leq 6$), for decimal fraction of a second, with each digit in range 0 ~ 9 (optional)
- Z** : a terminator

(2) Spacecraft Time Format (CDS)

Spacecraft Time Format contains the 64-bit CCSDS Day Segmented Time Code (DST) T-field. Spacecraft Time Code consists of a selected number of continuous time segments. Each segment represents the state of a binary counter, cascaded with the adjacent counters, which rolls over at a module specified for each counter.

Width (bits)	Description	Units
16	Days since 1958 January 1. The first bit is always '0'.	Days
32	Millisecond of Day (number milliseconds since beginning of current day)	msec
16	Microsecond of Millisecond (number microseconds in current millisecond)	μsec

1.4 Data Type Definitions

These definitions are used in comparison expressions to determine the type of data products.

Definition Name	Description
DATETIME	CCSDS ASCII Time Code (A format)
FLOAT	IEEE single-precision (32-bit) format float type
DOUBLE	IEEE double-precision (64-bit) format float type
STRING	A text string value consists of a text string lexical elements
INT8	8-bit integer type
UINT8	8-bit unsigned integer type
INT16	16-bit integer type
UINT16	16-bit unsigned integer type
INT32	32-bit integer type
UINT32	32-bit unsigned integer type
INTEGER	Same as INT32

1.5 Strip Observation Mode

Following definitions are used in comparison expressions to determine the strip observation mode. Table 1.5-1 shows the methodological concept for deciding the strip observation mode at sensor operate. Table 1.5-2 expresses the conceptual view of the strip observation mode.

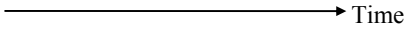















Table 1.5-1 Strip Observation Mode

ASTER OBS Mode*1				Processed Bands	Sensor Short Name	Strip Observation Mode	
VNIR 1	VNIR2	SWIR	TIR			Estimatable Mode	Table
ON	ON	ON	ON	“01023N3B0405060708091011121314”	‘ASTER_VNIR’, ‘ASTER_SWIR’, ‘ASTER_TIR’	VST	(1)
						VST+T	(6)
ON	ON	OFF	OFF	“01023N3BXXXXXXXXXXXXXXXXXXXX XXXXXX”	‘ASTER_VNIR’,	V	(2)
OFF	OFF	OFF	ON	“XXXXXXXXXXXXXXXXXXXXXXXXXXXX101 1121314”	‘ASTER_TIR’	T	(3)
OFF	OFF	ON	ON	“XXXXXXXXXX04050607080910111213 14”	‘ASTER_SWIR’, ‘ASTER_TIR’	ST	(4)
						ST+T	(7)
OFF	ON	OFF	OFF	“XXXX3N3BXXXXXXXXXXXXXXXXXXXX XXXXXX”	‘ASTER_STEREO’	V Stereo	(5)
ON	ON	ON	ON	“XXXXXXXXXXXXXXXXXXXXXXXXXXXX101 1121314”	‘ASTER_TIR’	VST+T	(6)
OFF	OFF	ON	ON	“XXXXXXXXXXXXXXXXXXXXXXXXXXXX101 1121314”	‘ASTER_TIR’	ST+T	(7)

NOTES:

- (*1) Refer to the table 2.3.1-2, item 9.2.1 ‘**ASTERObservationMode**
- (*2) Refer to the table 2.3.1-2, item 9.3 ‘**ProcessedBands**
- (*3) Refer to the table 2.3.1-3, item 2 ‘**SensorShortName**
- (*4) See the table 1.1-2 Coneptual view of strip observation mode.

Table 1.5-2 Conceptual view of strip observation mode

Sensor	Sensor operation by mode based on time coordinate 
(1) VST (full) mode	
VNIR1	
VNIR2	
SWIR	
TIR	
(2) V mode	
VNIR1	
VNIR2	
(3) T mode	
TIR	
(4) ST mode	
SWIR	
TIR	
(5) V Stereo mode	
VNIR2	
(6) VST+T mode	
VNIR1	
VNIR2	
SWIR	
TIR	
(7) ST+T mode	
SWIR	
TIR	

1.6 Map Projection Parameters

This section describes the definition of the map projection parameters used in LIB processing. The software uses the geo-coordinate transformation (GCT) tools, based on the commonly available packages general cartographic transformation package (GCTP), contained in the SDP Toolkit routines.;

Table 1.5-3 Projection Transformation Package Projection Parameters Elements (1/2)

Name	Array Element ^{*1}							
	1	2	3	4	5	6	7	8
UTM ^{*2}	SMajor	SMinor	Factor		CentMer	OriginLat	FE	FN
LAMCC	SMajor	SMinor	STDPR1	STDPR2	CentMer	OriginLat	FE	FN
PS	SMajor	SMinor			LongPol	LTrueScale	FE	FN
EQRECT	Sphere				CentMer	LTrueScale	FE	FN
SOM	SMajor	SMinor		IncAng	AscLong		FE	FN

Table 1.5-3 Projection Transformation Package Projection Parameters Elements (2/2)

Name	Array Element ^{*1}				
	9	10	11	12	13
UTM ^{*2}					
LAMCC					
PS					
EQRECT					
SOM	PSRev	LRat	PFlag		zero

NOTES:

- (*1) All array elements with blank fields are set to zero. All angles are in radians.
(Longitude is negative west of Greenwich, Latitude is negative south of equator.)
- (*2) The software of ASTER Level-1 Data Processing Subsystem uses the TM in place of UTM, for the treatments of the scene across the zone boundary.

where,

SMajor	Semi-major axis of the ellipsoid
SMinor	Semi-minor axis of the ellipsoid
Sphere	Radius of reference sphere
STDPR1	Latitude of the first standard parallel
STDPR2	Latitude of the second standard parallel
CentMer	Longitude of the central meridian
OriginLat	Latitude of the projection origin
FE	False easting in the same units as the semi-major axis
FN	False northing in the same units as the semi-major axis
LTrueScale	Latitude of true scale
LongPol	Longitude down below pole of map
Factor	Scale factor at central meridian
CentLat	Latitude of center of projection
IncAng	Inclination of orbit at ascending node, counter-clockwise from equator
AscLong	Longitude of ascending orbit at equator
PSRev	Period of satellite revolution in minutes
LRat	Landsat ratio to compare for confusion at northern end of orbit (ASTER: 0.5201613)
PFlag	End of path flag for Landsat: 0 = start of path, 1 = end of path (ASTER: 0)
zero	0.0

2. Level 1A Data Product

2.1 Overview

Level 1A Data Product is an HDF file. Each file contains a complete 1-scene image data extracted from Level-0 data and corrected for the SWIR and TIR detector's alignment. Furthermore it includes also the radiometric, the geometric and the SWIR parallax correction tables, spacecraft's supplement data, the satellite ancillary data, and the calculated cloud coverage values. All of these data are stored together with Metadata, SDS, Vgroup/Vdata, and Swath Layout parts in one HDF file.

Level 1A Data defines a scene center on the spectral image as (l, p), where 'l' and 'p' are estimated from the following equations.

$$l = \text{Tranc}(\text{number of lines in scene} / 2) + 1$$

$$p = \text{Tranc}(\text{number of pixels per line} / 2) + 1$$

Tranc(x) truncates the value to the greatest integral value less than or equal to x.

2.2 Data Structure

(1) Data Type

Level 1A Data Product within HDF file is constructed from six categories of HDF data object.

Note: VNIR (4 bands) and SWIR (6 bands) image data are 8-bit unsigned integer science data, and TIR (5 bands) image data are 16-bit unsigned integer science data, stored to the Swath object at every band.

(2) Data Structure

The physical format of Level 1A Data Product is shown in Figure 2.2-1. Data structure represented in Figure 2.2-1 shows the conceptual view of the physical format of the product in case of full mode (VST) operation. Some category shall not set in the product, in case that it can not be applied to the dataset on account of the selected operational mode; i.e., V, V stereo, ST, T, etc.

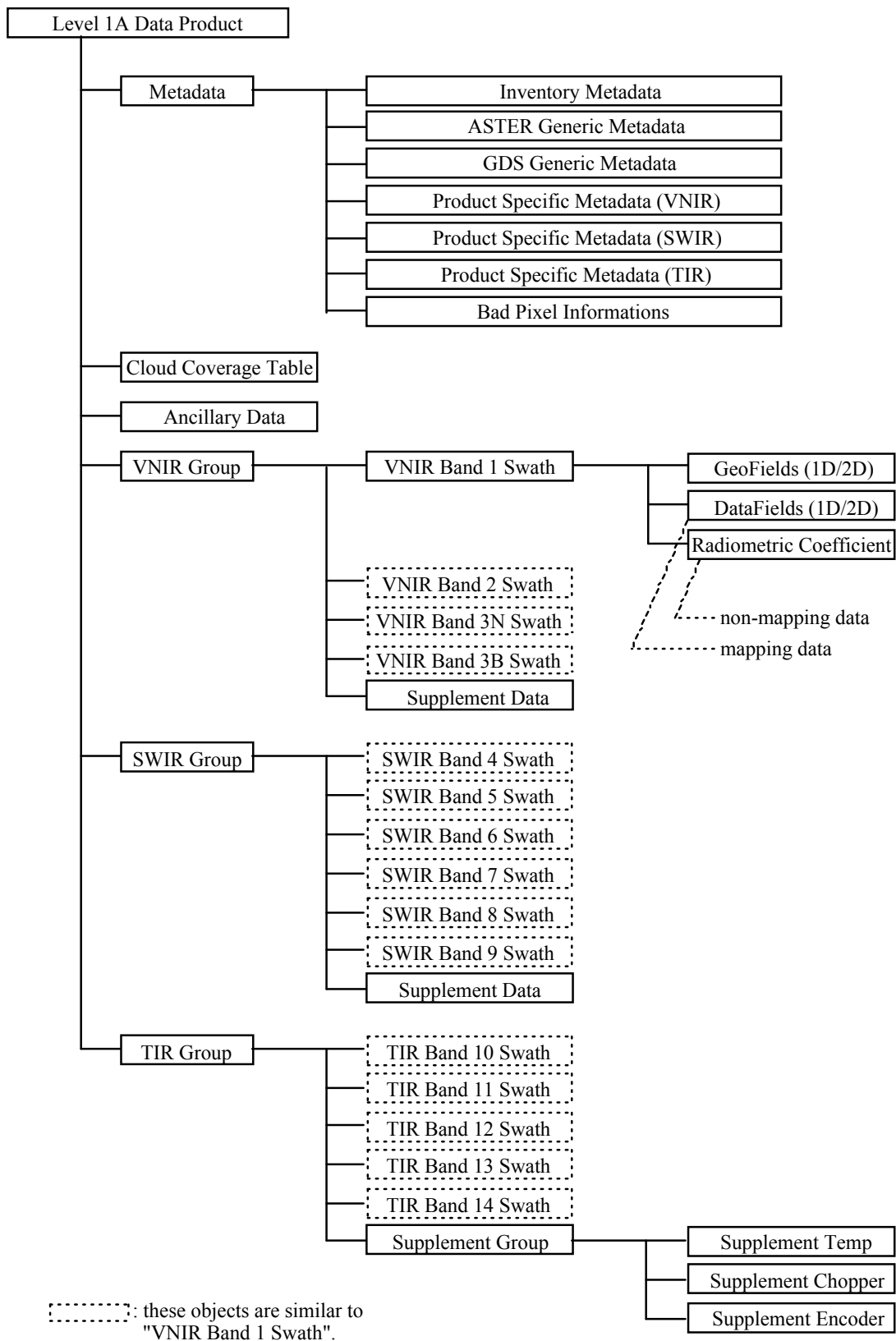

Figure 2.2-1 Physical Data of Level 1A Data Product

2.3 Data Format

2.3.1 Metadata

Level 1A Metadata consists of seven Master Groups, which are named as follows,

- (1) InventoryMetadata
- (2) ASTERGenericMetadata
- (3) GDSGenericMetadata
- (4) ProductSpecificMetadataVNIR :including the attribute about band-1, 2, 3N, 3B data and input (Level0) data.
- (5) ProductSpecificMetadataSWIR :including the attribute about band-4, 5, 6, 7, 8, 9 data and input (Level0) data.
- (6) ProductSpecificMetadataTIR :including the attribute about band-10,11, 12, 13, 14 data and input (Level0) data.
- (7) BadPixelInformation :including the attribute about lists of bad pixels every band.

About concept and definition of master groups, refer to SCF Toolkit Users Guide for the ECS Project, Appendix J.

The term “metadata” relates to all information of a descriptive nature that is associated with a product or dataset. This includes information that identifies a dataset, giving characteristics such as its origin, contents, quality, and condition. Metadata can also provide information needed to decode, process and interpret the data, and can include items such as the software that was used to create the data. Metadata entries are described in Object Description Language (ODL) and CLASS system (for two-dimensional arrays). Details are provided in Appendix J of the SCF Toolkit Users Guide (Reference [8]).

2.3.1.1 Inventory Metadata

(1) Indexes of Objects

The object list of Inventory Metadata is shown in Table 2.3.1-1. Inventory Metadata attributes apply to the whole L1A product, and are written to the HDF file attribute named “**coremetadata.0**”.

Inventory Metadata contains ASTER Meta-Parameters in Generic header for ASTER GDS Products (about Generic header for ASTER GDS Products, see ASTER LEVEL 1 DATA PRODUCTS SPECIFICATION -- Applicable [3]). The attributes included in Inventory Metadata are associated with 311-CD-002-005 (DID311 -- Reference [9]).

(In Table 2.3.1-1, group names are written in **Bold** characters. A group contains a set of objects that all have a similar theme.)

Table 2.3.1-1 List of Objects in Inventory Metadata (1/2)

No.	Group/Object Name	type* ¹	Description
1	ShortName	string	The short name for information that identifies a dataset: ‘ASTL1A’
2	SizeMBDataGranule	double	The volume of data contained in the granule. Unit: Mbytes
3	ProductionDateTime	datetime	Generation date and time of this Level 1A product.
4	PlatformShortName	string	‘AM-1’ fixed.
5	InstrumentShortName	string	‘ASTER’ fixed.
6	BoundingRectangle		This block contains area coverage for a granule.
	1 WestBoundingCoordinate	double	Western-most coordinate of the scene expressed in longitude.
	2 NorthBoundingCoordinate	double	Northern-most coordinate of the scene expressed in geodetic latitude.
	3 EastBoundingCoordinate	double	Eastern-most coordinate of the scene expressed in longitude.
	4 SouthBoundingCoordinate	double	Southern-most coordinate of the scene expressed in geodetic latitude.

Table 2.3.1-1 List of Objects in Inventory Metadata (2/2)

No.	Group/Object Name	type*1	Description
7	SingleDateTime		This contains the time of day and calendar date, at which the center of the scene is observed.
	1 TimeOfDay	string	format: hhmmssd...dZ
	2 CalendarDate	string	format: YYYYMMDD
8	Review		This block provides for dates and status as applicable for collection that are active.
	1 FutureReviewDate	string	The date of the nearest planned QA peer review in future. format: YYYYMMDD
	2 ScienceReviewDate	string	The date of the last QA peer review. format: YYYYMMDD
9	QAStats		This block contains measures of quality for a granule.
	1 QAPercentMissingData	double	The percentage of missing data in the scene. Unit: %
	2 QAPercentOutofBoundsData	double	The percentage of out of bounds data in the scene. Unit: %
	3 QAPercentInterpolatedData	double	The percentage of interpolated data in the scene. Unit: %
10	ReprocessingActual	string	The stating what reprocessing has been performed on this granule. {'not reprocessed', 'reprocessed once', 'reprocessed twice', 'reprocessed n times'}
11	PGEVersion	string	The version of PGE
12	ProcessingLevelID	string	The classification of the science data processing level: '1A'
13	MapProjectionName	string	The type of map projection used: 'N/A'

NOTES:

- (*1) Object types used in Metadata are
- datetime: CCSDS A (UTC) Format
 - integer
 - double: the floating point value is rounded to the appropriate number (6 digits after the decimal-point character).
 - string

2.3.1.2 ASTER Generic Metadata

(1) Indexes of Objects

The Object list of ASTER Generic Metadata is shown in Table 2.3.1-2. ASTER Generic Metadata attributes are written to the HDF file attribute named “**productmetadata.0**”.

The baseline of the scene location is VNIR band 2 for a set of 3 sensors V+S+T, and others use SWIR band 6 or TIR band 11 for S+T or T, respectively.

ASTER Generic Metadata contains ASTER Parameters in Generic Header for ASTER GDS Products (about Generic header for ASTER GDS Products, see ASTER LEVEL 1 DATA PRODUCTS SPECIFICATION -- Applicable [3]). The ASTER Parameters are the specific attributes, i.e. not associated with DID311.

(In Table 2.3.1-2, group names are written in **Bold** characters. A group contains a set of objects that all have a similar theme.)

Table 2.3.1-2 List of Object in ASTER Generic Metadata (1/5)

No.	Group/Object Name	type*1	Description
1	IDofASTERGDSDataGranule	string	This provides a unique identifier for location of a data granule held in ASTER GDS. Format: ‘ASTL1A YYMMDDHH MMSSyymmddNNNN’ where, YYMMDD:observation date HHMMSS:observation time yymmdd:the data granule generation date NNNN:the data granule sequential No. (per day)
2	ReceivingCenter	string	‘EDOS’ fixed.
3	ProcessingCenter	string	‘ASTER-GDS’ fixed.
4	PointingAngles		Specification of the pointing angles of ASTER sensors.
	PointingAnglesContainer(n)*2		n = number of sensors
	1 SensorName(n)*2	string	‘VNIR’ or ‘SWIR’ or ‘TIR’
	2 PointingAngle(n)*2	double	pointing angle in degrees
3	SettingTimeofPointing(n)*2	datetime	YYYY-MM-DDThh:mm:ss.d...dZ
5	GainInformation		The information of the gain level.
	GainInformationContainer(n)*2		This container contains the level of the data acquisition gain for VNIR and SWIR.

Table 2.3.1-2 List of Object in ASTER Generic Metadata (2/5)

No.	Group/Object Name	type*1	Description
5	1	Gain(n)*2	string (Band Number, Band Gain) where, Band Number: '01','02','3N','3B','04','05','06','07','08','09' Band Gain: for VNIR: 'HGH': high gain 'NOR': normal gain 'LOW': low gain for SWIR: 'HGH': high gain 'NOR': normal gain 'LO1': low gain 1 'LO2': low gain 2 when data is not acquired or doesn't exist: 'OFF'
6	CalibrationInformation		Calibration information used to generate the geometric and radiometric correction tables.
	1	GeometricDBversion	string The version information of the geometric correction data. (Version, Issuancedate, Comments) where, Version: Version No. Issuancedate: Issuance Date Comments: Comments
	2	RadiometricDBversion	string The version information of the radiometric correction data. (Version, Issuancedate, Comments) where, Formats of these parameters are the same as Item 6.1.
	3	CoarseDEMversion*3	string The version information of the Coarse DEM database. (Version, Issuancedate, Comments) where, Formats of these parameters are the same as Item 6.1.
7	DataQuality		The information about the quality of this product.
	1	CloudCoverage	The information about the cloud coverage of the scene
		1	SceneCloudCoverage integer The percentage of cloud coverage for the whole scene. Unit: %

Table 2.3.1-2 List of Object in ASTER Generic Metadata (3/5)

No.			Group/Object Name	type*1	Description
7	1	2	QuadrantCloudCoverage	integer	The percentage for 4 quarters of a scene. (qcul, qcur, qcll, qclr) where, qcul: upper left qcur: upper right qcll: lower left qclr: lower right Unit: %
8			SourceDataProduct	string	The information about the input data used for generating this Level-1A product. (DataID, GenDT, DataTyp) where, DataID: 'N/A' fixed. GenDT: 'N/A' fixed. DataTyp: Data type, 'PDS' or 'EDS' or 'DDS'.
9			InstrumentInformation		The information about sensors used to acquire data.
	1		ASTEROperationMode	string	The types of ASTER operation. 'OBSERVATION' or 'CALIBRATION' or 'TEST'
	2		ObservationMode		This group contains ASTER observation mode.
			ObservationModeContainer(n) *2		The container of ASTER observation mode.
		1	ASTERObservationMode(n)*2	string	The observation mode of each sensor group. (SGname, Observation) where, SGname: 'VNIR1' or 'VNIR2' or 'SWIR' or 'TIR' Observation: 'ON' (data is acquired) or 'OFF' (data is not acquired, or not existing in the granule)
	3		ProcessedBands	string	The status of all bands during observation. Format: set of flags described as 2-bytes string. flag = 01,02,3N,3B,~,~ ,14 (data of band 01, 02,3N,~,~ ,14 is used in the granule generation) = XX (data corresponding to the band position marked with XX is not used) Example: Value = 'XXXXXXXXX0405060708091011121314'

Table 2.3.1-2 List of Object in ASTER Generic Metadata (4/5)

No.	Group/Object Name	type*1	Description	
10	SceneInformation		The information about the scene concerning with the data granule.	
	1	ASTERSceneID	integer	The scene identifier defined by path, row and view. (path, row, view) where, path: 1-233 (nominal) row: 1-670 view: 1-7 (-1 for off-nominal pointing)
	2	OrbitNumber*4	integer	The orbit number of the satellite, when data is acquired.
	3	RecurrentCycleNumber*4	integer	The satellite recurrent cycle number and the revolution number in the cycle. (cycle , revolution) where, cycle: 1-260 (max.) revolution: 1-233 (nominal)
	4	FlyingDirection	string	The satellite flight direction when observation is done. 'AS': ascending direction. 'DE': descending direction.
	5	SolarDirection	double	The sun direction as seen from the scene center. (az, el) where, az: azimuth angle in degree. $0.0 \leq az < 360.0$ measured eastward from North. el: elevation angle in degree. $-90.0 \leq el \leq 90.0$
	6	SpatialResolution	integer	The nominal spatial resolutions of VNIR, SWIR and TIR. (resolution of VNIR, resolution of SWIR, resolution of TIR) Unit: meter
	7	SceneFourCorners		This group contains the information about 4 corner coordinates of the scene.
	1	UpperLeft	double	This denotes the coordinates of the upper-left corner of the scene. (lat, long) where, lat: geodetic latitude long: geodetic longitude Unit: degree

Table 2.3.1-2 List of Object in ASTER Generic Metadata (5/5)

No.			Group/Object Name	type*1	Description
10	7	2	UpperRight	double	This denotes the coordinates of the upper-right corner of the scene. (lat, long) where, Formats of these parameters are the same as Item 10.7.1
		3	LowerLeft	double	This denotes the coordinates of the lower-left corner of the scene. (lat, long) where, Formats of these parameters are the same as Item 10.7.1
		4	LowerRight	double	This denotes the coordinates of the lower-right corner of the scene. (lat, long) where, Formats of these parameters are the same as Item 10.7.1
	8	SceneCenter	double	Longitude and latitude of the scene center. (lat, long) where, lat: geodetic latitude -90.0≤lat≤90.0 long: East longitude -180.0≤long<180.0 Unit: degree	
	9	SceneOrientationAngle	double	This denotes the azimuth angle made by the meridian at scene center and the along-track direction, rotating from North toward East, within the range [0.0, 180.0] of the scene VNIR band 2 for a set of sensors V+S+T. SWIR band 4 for S+T, and TIR band 11 for T alone are used, respectively (Unit: degree).	

NOTES:

(*1) Object types used in Metadata are

a. datetime: CCSDS A (UTC) Format

b. integer

c. double: the floating point value is rounded to the appropriate number
(6 digits after the decimal-point character).

d. string

(*2) Object whose name followed by (n) has “class” attribute. It may repeat n-times.

(*3) Level-1 data product generation software needs GTOPO30 as the source of the ASTER Coarse DEM data.

(*4) This object is copied from the value denoted in the schedule information that AOS provided.

2.3.1.3 GDS Generic Metadata

(1) Indexes of Objects

The Object list of GDS Generic Metadata is shown in Table 2.3.1-3. GDS Generic Metadata attributes are written to the HDF file named attribute “**productmetadata.1**”.

GDS Generic Metadata contains the generic header specified by GDS, for ASTER GDS products. The attributes included in GDS Generic Metadata are the specific attributes, i.e. not associated with DID311 nor the ASTER Parameters.

Table 2.3.1-3 List of Object in GDS Generic Metadata

No.	Object Name	type*1	Description
1	SensorShortName	string	The redundant array of short name for all sensors using in generating the product*2: 'ASTER_VNIR', 'ASTER_SWIR', 'ASTER_TIR', 'ASTER_STEREO'
2	IDofASTERGDSDataBrowse	string	The ID of ASTER GDS browse granule generated using this Level 1A data product.

NOTES:

(*1) Object types used in Metadata are

- a. datetime: CCSDS A (UTC) Format
- b. integer
- c. double: the floating point value is rounded to the appropriate number (6 digits after the decimal-point character).
- d. string

(*2) This item ‘SensorShortName’ contains all available sensor short names.

- e.g., for a set of sensors V+S+T: (‘ASTER_VNIR’, ‘ASTER_SWIR’, ‘ASTER_TIR’)
- for S+T: (‘ASTER_SWIR’, ‘ASTER_TIR’)

2.3.1.4 Product Specific Metadata(VNIR)

(1) Indexes of Objects

The Object list of Product Specific Metadata(VNIR) is shown in Table 2.3.1-4. Product Specific Metadata(VNIR) attributes are written to the HDF file attribute named “**productmetadata.v**”.

Product Specific Metadata(VNIR) includes product specific attributes, i.e. not associated with DID311. (In Table 2.3.1-4, group names are written in **Bold** characters. A group contains a set of objects that all have a similar theme.)

Table 2.3.1-4 List of Object in Level 1A Product Specific Metadata(VNIR) (1/7)

No.	Group/Object Name	type*1	Description
1	VNIRBand1Data		The information about VNIR band 1 of Level-1A.
1	ExtractionfromL01		The information about the extraction from Level-0 Group-1 PDSs (PDSs contains VNIR band 1 and band 2 strip data) in order to make VNIR Band 1 Data.
	ExtractionfromL01 Container(n)*2		
1	RSC1(n)*2	integer	RSC (relative scan count) of the first (n=1) or the last (n=2) scan (≥ 0). RSC is scan count in each PDS.
2	SST1(n)*2	datetime	SST (scan start time) of the first (n=1) or the last (n=2) scan.
3	PDSid1(n)*2	string	Identifier of PDS including the first (n=1) or the last (n=2) scan.
2	ImageDataInformation1	integer	The information of VNIR band 1 image data. (npx, nln, bpp) where, npx: Number of pixels per line (4100: fixed) nln: Number of lines in frame (4200: nominal) bpp: Bytes per pixel (1: fixed)

Table 2.3.1-4 List of Object in Level 1A Product Specific Metadata(VNIR) (2/7)

No.	Group/Object Name	type*1	Description	
1	3	GeometricCorrection1	integer	The information of VNIR Band-1 Swath geolocation field. (nlpat, nlpct, dlpat, dlpct) where, nlpat: number of lattice points in along-track direction. (12: nominal) nlpct: number of lattice points in cross-track direction. (11: nominal) dlpat: distance between two neighbor lattice points in along-track direction. (400: nominal) dlpct: distance between two neighbor lattice points in cross-track direction. (410: nominal)
	4	RadiometricCorrection1	integer	The information of VNIR Band-1 radiometric correction table (stored in VNIR Band-1 Swath). (ndct, npara) where, ndct: number of detectors used. (4100: fixed) npara: number of parameters (3: fixed)
	5	DataQuality1		This group contains the information about the quality of Level 1A VNIR Band-1 data.
	1	NumberofBadPixels1	integer	The information about bad pixels. (nmp, ndd, nelm) where, nmp: number of missing pixels. ndd: number of damaged detectors. nelm: number of elements of the list of bad pixels*3.
	6	UnitConversionCoeff1		This group contains the coefficients used for radiance conversion, from the pixel value of the band-1 image.
	1	Incl1	double	Inclination Value
	2	Offset1	double	Offset Value
	3	ConUnit1	string	Converted Unit 'W/m ² /sr/μm' fixed.
	7	DestripeParameter1		This group denotes the information about destripe parameters for Band 1 image data.
	1	NumberofParameters1	integer	Total number of destripe parameters.

Table 2.3.1-4 List of Object in Level 1A Product Specific Metadata(VNIR) (3/7)

No.			Group/Object Name	type*1	Description
1	7	2	ListofParameters1	string*4	Destripe Parameters (DP1, DP2, DP3,.....,DPn) n= Number of Parameters1
2 ~ 2.7.2			For next VNIRBand2Data , repeat the above items (1 through 1.7.2).		
3			VNIRBand3NData		The information about VNIR band 3N of Level-1A.
1			ExtractionfromL03N		The information about the extraction from Level-0 Group-2 PDSs (PDSs contains VNIR band 3N and band 3B strip data) in order to make VNIR Band 3N Data.
			ExtractionfromL03NContainer(n)*2		
1			RSC3N(n)*2	integer	RSC (relative scan count) of the first (n=1) or the last (n=2) scan (≥ 0). RSC is scan count in each PDS.
2			SST3N(n)*2	datetime	SST (scan start time) of the first (n=1) or the last (n=2) scan.
3			PDSid3N(n)*2	string	Identifier of PDS including the first (n=1) or the last (n=2) scan.
2			ImageDataInformation3N	integer	The information of VNIR Band 3N image data. (npx, nln, bpp) where, npx: Number of pixels per line (4100: fixed) nln: Number of lines in frame (4200: nominal) bpp: Bytes per pixel (1: fixed)
3			GeometricCorrection3N	integer	The information of VNIR Band-3N Swath geolocation field. (nlpat, nlpct, dlpat, dlpct) where, nlpat: number of lattice points in along-track direction. (12: nominal) nlpct: number of lattice points in cross-track direction. (11: nominal) dlpat: distance between two neighbor lattice points in along-track direction. (400: nominal) dlpct: distance between two neighbor lattice points in cross-track direction. (410: nominal)

Table 2.3.1-4 List of Object in Level 1A Product Specific Metadata(VNIR) (4/7)

No.	Group/Object Name	type*1	Description	
3	4	RadiometricCorrection3N	integer	The information of VNIR Band-3N radiometric correction table (stored in VNIR Band 3N Swath). (ndct, npara) where, ndct: number of detectors used. (4100: fixed) npara: number of parameters (3: fixed)
	5	DataQuality3N		This group contains the information about the quality of Level 1A VNIR Band-3N data.
	1	NumberOfBadPixels3N	integer	The information of missing data. (nmp, ndd, nelm) where, nmp: number of missing pixels. ndd: number of damaged detectors. nelm: number of elements of the list of bad pixels*3.
	6	UnitConversionCoeff3N		This group contains the coefficients used for radiance conversion, from the pixel value of the band-3N image.
	1	Incl3N	double	Inclination Value
	2	Offset3N	double	Offset Value
	3	ConUnit3N	string	Converted Unit 'W/m ² /sr/μm' fixed.
	7	DestripeParameter3N		This group denotes the information about destripe parameters for Band 3N image data.
	1	NumberOfParameters3N	integer	Total number of destripe parameters.
	2	ListofParameters3N	string*4	Destripe Parameters (DP1, DP2, DP3,.....,DPn) n= Number of Parameters3N
	4	VNIRBand3BData		The information about VNIR band 3B of Level-1A.
	1	ExtractionfromL03B		The information about the extraction from Level-0 Group-2 PDSs (PDSs contains VNIR band 3N and band 3B strip data) in order to make VNIR Band 3B Data.
		ExtractionfromL03BContainer(n)*2		
1	RSC3B(n)*2	integer	RSC (relative scan count) of the first (n=1) or the last (n=2) scan (≥ 0). RSC is scan count in each PDS.	
2	SST3B(n)*2	datetime	SST (scan start time) of the first (n=1) or the last (n=2) scan.	

Table 2.3.1-4 List of Object in Level 1A Product Specific Metadata(VNIR) (5/7)

No.			Group/Object Name	type*1	Description
4	1	3	PDSid3B(n)*2	string	Identifier of PDS including the first (n=1) or the last (n=2) scan.
		2	ImageDataInformation3B	integer	The information of VNIR Band 3B image data. (npx, nln, bpp) where, npx: Number of pixels per line (5000: fixed) nln: Number of lines in frame (5400: nominal) bpp: Bytes per pixel (1: fixed)
	3	3	GeometricCorrection3B	integer	The information of VNIR Band-3B Swath geolocation field. (nlpat, nlpct, dlpat, dlpct) where, nlpat: number of lattice points in along-track direction. (15: nominal) nlpct: number of lattice points in cross-track direction. (11: nominal) dlpat: distance between two neighbor lattice points in along-track direction. (400: nominal) dlpct: distance between two neighbor lattice points in cross-track direction. (500: nominal)
		4	RadiometricCorrection3B	integer	The information of VNIR Band-3B radiometric correction table (stored in VNIR band 3B Swath). (ndct, npara) where, ndct: number of detectors used. (5000: fixed) npara: number of parameters (3: fixed)
		5	DataQuality3B		This group contains the information about the quality of Level 1A VNIR Band-3B data.
		1	NumberofBadPixels3B	integer	The information about bad pixels. (nmp, ndd, nelm) where, nmp: number of missing pixels. ndd: number of damaged detectors. nelm: number of elements of the list of bad pixels*3.

Table 2.3.1-4 List of Object in Level 1A Product Specific Metadata(VNIR) (6/7)

No.	Group/Object Name	type*1	Description		
4	6	UnitConversionCoeff3B	This group contains the coefficients used for radiance conversion, from the pixel value of the band-3B image.		
		1	Incl3B	double	Inclination Value
		2	Offset3B	double	Offset Value
		3	ConUnit3B	string	Converted Unit 'W/m ² /sr/μm' fixed.
	7	FirstPixelAddressGroup		This group identifies the address of the first available pixel in each refreshing cycle of VNIR band-3B image data.	
		1	Ncycles	integer	Number of refreshing cycle. (nominal = 10)
		2	FPAddress		This identifies the address of the first available pixel in each refreshing cycle of VNIR band-3B image data.
			FPAddressContainer(n)*2		
		1	FirstPixelAddress(n)*2	integer	(Sc, Ad) where, Sc: Relative scan count Ad: Address
	8	DestripeParameter3B		This group denotes the information about destripe parameters for Band 3B image data.	
		1	NumberofParameters3B	integer	Total number of destripe parameters.
2		ListofParameters3B	string*4	Destripe Parameters (DP1, DP2, DP3,.....,DPn) n= Number of Parameters3B	
5	Level0VNIRG1Data		The information about Level-0 Group-1 which contains VNIR band 1 and 2 data.		
	1	L0DataSetG1		This group contains the information of L0 Group-1 data set (PDSs).	
		L0DataSetG1Container(n)*2		The information about PDSs of Level-0 Group-1.	
		1	PDSidG1(n)*2	string	Identifier of this PDS assigned by EDOS.
		2	FirstPacketTimeG1(n)*2	datetime	First packet time for this PDS.
		3	LastPacketTimeG1(n)*2	datetime	Last packet time for this PDS.
		4	PacketCountsG1(n)*2	integer	Number of packets in this PDS.
	2	L0DataTypeG1	string	The identifier of the input data type (defined by EDOS). 'PDS': Production Data Set 'EDS': Expedited Data Set 'DDS': Direct down-link Data Set 'TEST': Test Data	

Table 2.3.1-4 List of Object in Level 1A Product Specific Metadata(VNIR) (7/7)

No.	Group/Object Name	type*1	Description				
5	3	L0DataQualityG1	This specifies the number of input packets used to generate the data granule, and their quality.				
		1	SensorGroupNameG1	string	Sensor group name: 'VNIR1' (fixed)		
		2	NumberOfPacketsG1	integer	Number of packets used to generate the scene data of each group.		
		3	PercentofMissingPacketsG1	double	The percentage of missing packets of each group. Unit: %		
		4	PercentofCorrectedPacketsG1	double	The percentage of packets with errors corrected by Reed Solomon (R-S) decoding. Unit: %		
6	1	Level0VNIRG2Data	The information about Level-0 Group-2 which contains VNIR band 3N and 3B data.				
		L0DataSetG2	This group contains the information of L0 Group-2 data set (PDSs).				
		L0DataSetG2Container(n)*2		The information about PDSs of Level-0 Group-2.			
		1	PDSidG2(n)*2	string	Identifier of this PDS assigned by EDOS.		
		2	FirstPacketTimeG2(n)*2	datetime	First packet time for this PDS.		
		3	LastPacketTimeG2(n)*2	datetime	Last packet time for this PDS.		
		4	PacketCountsG2(n)*2	integer	Number of packets in this PDS.		
		2	L0DataTypeG2	string	The identifier of the input data type (defined by EDOS). 'PDS': Production Data Set 'EDS': Expedited Data Set 'DDS': Direct down-link Data Set 'TEST': Test Data		
		3	L0DataQualityG2		This specifies the number of input packets used to generate the data granule, and their quality.		
				1	SensorGroupNameG2	string	Sensor group name: 'VNIR2' (fixed)
				2	NumberOfPacketsG2	integer	Number of packets used to generate the scene data of each group.
				3	PercentofMissingPacketsG2	double	The percentage of missing packets of each group. Unit: %
				4	PercentofCorrectedPacketsG2	double	The percentage of packets with errors corrected by Reed Solomon (R-S) decoding. Unit: %

NOTES:

(*1) Object types used in Metadata are

a. datetime: CCSDS A (UTC) Format

b. integer

c. double: the floating point value is rounded to the appropriate number (6 digits after the decimal-point character).

d. string

(*2) Object whose name followed by (n) has "class" attribute. It may repeat n-times.

- (*3) The information concerning the list of bad pixels apart from this attribute and is written to the separated attribute named “badpixelinformation”. Refer to the section 2.3.1.7, titled *Bad Pixel Information*.
- (*4) SCF Toolkit does not support exponential numbers correspond to the Third Numerical Representation (NR3) in ISO 6093, then this should be expressed as a quoted strings. Each number is represented by two sequences of decimal digits called the significant (i.e., mantissa) and exponent, separated by the ASCII character **E** (e.g. **Value**=(“+1.23E-1”, “-4.99E+2”).

2.3.1.5 Product Specific Metadata(SWIR)

(1) Indexes of Objects

The Object list of Product Specific Metadata(SWIR) is shown in Table 2.3.1-5. Product Specific Metadata(SWIR) attributes are written to the HDF file attribute named “**productmetadata.s**”. Product Specific Metadata(SWIR) includes product specific attributes, i.e. not associated with DID311. (In Table 2.3.1-5, group names are written in **Bold** characters. A group contains a set of objects that all have a similar theme.)

Table 2.3.1-5 List of Object in Level 1A Product Specific Metadata(SWIR) (1/4)

No.	Group/Object Name	type*1	Description
1	SWIRBand4Data		The information about SWIR band 4 of Level-1A.
1	ExtractionfromL04		The information about the extraction from Level-0 Group-3 PDSs (PDSs contains SWIR strip data) in order to make SWIR band 4 data.
	ExtractionfromL04Container(n)*2		
1	RSC4(n)*2	integer	RSC (relative scan count) of the first (n=1) or the last (n=2) scan (≥ 0). RSC is scan count in each PDS.
2	SST4(n)*2	datetime	SST (scan start time) of the first (n=1) or the last (n=2) scan.
3	PDSid4(n)*2	string	Identifier of PDS including the first (n=1) or the last (n=2) scan.
2	ImageDataInformation4	integer	The information of SWIR band 4 image data. (npx, nln, bpp) where, npx: Number of pixels per line (2048: fixed) nln: Number of lines in frame (2100: nominal) bpp: Bytes per pixel (1: fixed)

Table 2.3.1-5 List of Object in Level 1A Product Specific Metadata(SWIR) (2/4)

No.	Group/Object Name	type*1	Description
1 3	GeometricCorrection4	integer	The information of SWIR Band-4 Swath geolocation field. (nlpat, nlpct, dlpat, dlpct) where, nlpat: number of lattice points in along-track direction. (106: nominal) nlpct: number of lattice points in cross-track direction. (104: nominal) dlpat: distance between two neighbor lattice points in along-track direction. (20: nominal) dlpct: distance between two neighbor lattice points in cross-track direction. (20: nominal)
4	RadiometricCorrection4	integer	The information of SWIR Band-4 radiometric correction table (stored in SWIR band 4 Swath). (ndct, npara) where, ndct: number of detectors used. (2048: fixed) npara: number of parameters (3: fixed)
5	DataQuality4		This group contains the information about the quality of Level 1A SWIR Band-4 data.
1	NumberofBadPixels4	integer	The information about bad pixels. (nmp, ndd, nelm) where, nmp: number of missing pixels. ndd: number of damaged detectors. nelm: number of elements of the list of bad pixels*3.
6	UnitConversionCoeff4		This group contains the coefficients used for radiance conversion, from the pixel value of the band-4 image.
1	Incl4	double	Inclination Value
2	Offset4	double	Offset Value
3	ConUnit4	string	Converted Unit 'W/m ² /sr/μm' fixed.
7	DestripeParameter4		This group denotes the information about destripe parameters for Band 4 image data.
1	NumberofParameters4	integer	Total number of destripe parameters.

Table 2.3.1-5 List of Object in Level 1A Product Specific Metadata(SWIR) (3/4)

No.	Group/Object Name	type*1	Description	
1	7 2 ListofParameters4	string*4	Destripe Parameters (DP1, DP2, DP3,.....,DPn) n= Number of Parameters4	
2 ~ 2.7.2	For next SWIRBand5Data , repeat the above items (1 through 1.7.2).			
3 ~ 3.7.2	For next SWIRBand6Data , repeat the above items (1 through 1.7.2).			
4 ~ 4.7.2	For next SWIRBand7Data , repeat the above items (1 through 1.7.2).			
5 ~ 5.7.2	For next SWIRBand8Data , repeat the above items (1 through 1.7.2).			
6 ~ 6.7.2	For next SWIRBand9Data , repeat the above items (1 through 1.7.2).			
7	Level0SWIRData		The information about Level-0 Group-3 which contains SWIR data.	
1	L0DataSet		This group contains the information of L0 SWIR data set (PDSs).	
	L0DataSetContainer(n)*2		The information about PDSs of Level-0 Group-3.	
	1 PDSid(n)*2	string	Identifier of this PDS assigned by EDOS.	
	2 FirstPacketTime(n)*2	datetime	First packet time for this PDS.	
	3 LastPacketTime(n)*2	datetime	Last packet time for this PDS.	
	4 PacketCounts(n)*2	integer	Number of packets in this PDS.	
	2	L0DataType	string	The identifier of the input data type (defined by EDOS). 'PDS': Production Data Set 'EDS': Expedited Data Set 'DDS': Direct down-link Data Set 'TEST': Test Data
	3	L0DataQuality		This specifies the number of input packets used to generate the data granule, and their quality.
	1	SensorGroupName	string	Sensor group name : 'SWIR' (fixed)
	2	NumberofPackets	integer	Number of packets used to generate the scene data of each group.
	3	PercentofMissingPackets	double	The percentage of missing packets of each group. Unit: %
	4	PercentofCorrectedPackets	double	The percentage of packets with errors corrected by Reed Solomon (R-S) decoding. Unit: %
	8	SWIRRegistrationQuality		The registration information of SWIR based on VNIR.
1	ProcessingFlag	integer	0: no output, because processing is impossible. 1: output is the result computed. 2: output is extracted from registration file. 4: output obtained by other method.	

Table 2.3.1-5 List of Object in Level 1A Product Specific Metadata(SWIR) (4/4)

No.	Group/Object Name	type*1	Description	
8	2	NumberOfMeasurements	integer	The number of measurements
	3	MeasurementPointNumber	integer	The number of measurement points.
	4	AverageOffset	double	Average offset value. (LAOset, PAOset) where, LAOset: average offset in along track direction. PAOset: average offset in cross track direction.
	5	StandardDeviationOffset	double	Standard deviation offset value. (LSDOset, PSDOset) where, LSDOset: SD offset in along track direction. PSDOset: SD offset in cross track direction.
	6	Threshold	double	Threshold value. (CThld, LOThld, POThld, VOThld) where, CThld: Correction threshold LOThld: offset threshold in along track direction. POThld: offset threshold in cross track direction. VOThld: Vector offset threshold
	9	ParallaxCorrectionQuality		The information of SWIR parallax correction.
	1	PctImageMatch	integer	The percentage of image matching used in the SWIR parallax correction processing. Unit: %
	2	AvgCorrelCoef	double	The Average Correlation Coefficient.
	3	Cthld	double	The Correlation Threshold value.

NOTES:

- (*1) Object types used in Metadata are
 - a. datetime: CCSDS A (UTC) Format
 - b. integer
 - c. double: the floating point value is rounded to the appropriate number (6 digits after the decimal-point character).
 - d. string
- (*2) Object whose name followed by (n) has “class” attribute. It may repeat n-times.
- (*3) The information concerning the list of bad pixels apart from this attribute and is written to the separated attribute named “badpixelinformation”. Refer to the section 2.3.1.7, titled *Bad Pixel Information*.
- (*4) SCF Toolkit does not support exponential numbers correspond to the Third Numerical Representation (NR3) in ISO 6093, then this should be expressed as a quoted strings. Each number is represented by two sequences of decimal digits called the significant (i.e., mantissa) and exponent, separated by the ASCII character **E** (e.g. Value= (“+1.23E-1”, “-4.99E+2”)).

2.3.1.6 Product Specific Metadata(TIR)

(1) Indexes of Objects

The Object list of Product Specific Metadata(TIR) is shown in Table 2.3.1-6. Product Specific Metadata(TIR) attributes are written to the HDF file attribute named “**productmetadata.t**”.

Product Specific Metadata(TIR) includes product specific attributes, i.e. not associated with DID311.

(In Table 2.3.1-6, group names are written in **Bold** characters. A group contains a set of objects that all have a similar theme.)

Table 2.3.1-6 List of Object in Level 1A Product Specific Metadata(TIR) (1/4)

No.	Group/Object Name	type*1	Description
1	TIRBand10Data		The information about TIR band 10 of Level-1A.
1	ExtractionfromL010		The information about the extraction from Level-0 Group-4 PDSs (PDSs contains TIR strip data) in order to make TIR Band 10 data.
	ExtractionfromL04Container(n)*2		
1	RSC10(n)*2	integer	RSC (relative scan count) of the first (n=1) or the last (n=2) scan (≥0). RSC is scan count in each PDS.
2	SST10(n)*2	datetime	SST (scan start time) of the first (n=1) or the last (n=2) scan.
3	PDSid10(n)*2	string	Identifier of PDS including the first (n=1) or the last (n=2) scan.
2	ImageDataInformation10	integer	The information of TIR band 10 image data. (npx, nln, bpp) where, npx: number of pixels per line (700: fixed) nln: number of line in frame (700: nominal) bpp: bytes per pixel (2: fixed)
3	GeometricCorrection10	integer	The information of TIR band 10 Swath geolocation field. (nlpat, nlpct, dlpat, dlpct) where, nlpat: number of lattice points in along-track direction. (11: nominal) nlpct: number of lattice points in cross-track direction. (11: nominal) dlpat: distance between two neighbor lattice points in along-track direction. (70: nominal) dlpct: distance between two neighbor lattice points in cross-track direction. (70: nominal)

Table 2.3.1-6 List of Object in Level 1A Product Specific Metadata(TIR) (2/4)

No.	Group/Object Name	type*1	Description	
1	4	RadiometricCorrection10	integer	The information of TIR Band-10 radiometric correction table (stored in TIR band 10 Swath). (ndct, npara) where, ndct: number of detectors used. (10: fixed) npara: number of parameters (3: fixed)
	5	DataQuality10		This group contains the information about the quality of Level 1A TIR data.
	1	NumberofBadPixels10	integer	The information about bad pixels. (nmp, ndd, nelm) where, nmp: number of missing pixels. ndd: number of damaged detectors. nelm: number of elements of the list of bad pixels*3.
	6	UnitConversionCoeff10		This group contains the coefficients used for radiance conversion, from the pixel value of the band-10 image.
	1	Incl10	double	Inclination Value
	2	Offset10	double	Offset Value
	3	ConUnit10	string	Converted Unit 'W/m ² /sr/μm' fixed.
	7	DestripeParameter10		This group denotes the information about destripe parameters for Band 10 image data.
	1	NumberofParameters10	integer	Total number of destripe parameters.
	2	ListofParameters10	string*4	Destripe Parameters (DP1, DP2, DP3,.....,DPn) n= Number of Parameters10
2 ~ 2.7.2	For next TIRBand11Data , repeat the above items (1 through 1.7.2).			
3 ~ 3.7.2	For next TIRBand12Data , repeat the above items (1 through 1.7.2).			
4 ~ 4.7.2	For next TIRBand13Data , repeat the above items (1 through 1.7.2).			
5 ~ 5.7.2	For next TIRBand14Data , repeat the above items (1 through 1.7.2).			
6	Level0TIRData			The information about Level-0 Group-4 which contains TIR data.
	1	L0DataSet		This group contains the information of L0 TIR Group-10 data set (PDSs).
		L0DataSetContainer(n)*2		The information about PDSs of Level-0 Group-4 data.
	1	PDSid(n)*2	string	Identifier of this PDS assigned by EDOS.
	2	FirstPacketTime(n)*2	datetime	First packet time for this PDS.

Table 2.3.1-6 List of Object in Level 1A Product Specific Metadata(TIR) (3/4)

No.	Group/Object Name	type*1	Description		
6	1	3	LastPacketTime(n) ^{*2}	datetime	Last packet time for this PDS.
		4	PacketCounts(n) ^{*2}	integer	Number of packets in this PDS.
	2	L0DataType		string	The identifier of the input data type (defined by EDOS). 'PDS': Production Data Set 'EDS': Expedited Data Set 'DDS': Direct down-link Data Set 'TEST': Test Data
		L0DataQuality			This specifies the number of input packets used to generate the data granule, and their quality.
		1	SensorGroupName	string	Sensor group name: 'TIR' (fixed)
		2	NumberofPackets	integer	Number of packets used to generate the scene data of each group.
		3	PercentofMissingPackets	double	The percentage of missing packets of each group. Unit: %
	4	PercentofCorrectedPackets	double	The percentage of packets with errors corrected by Reed Solomon (R-S) decoding. Unit: %	
	7	TIRRegistrationQuality			The registration information of TIR based on VNIR.
		1	ProcessingFlag	integer	0: no output, because processing is impossible. 1: output is the result computed. 2: output is extracted from registration file. 4: output obtained by other method.
2			NumberofMeasurements	integer	The number of measurements
3			MeasurementPointNumber	integer	The number of measurement points.
4			AverageOffset	double	Average offset value. (LAOset, PAOset) where, LAOset: average offset in along track direction. PAOset: average offset in cross track direction.

Table 2.3.1-6 List of Object in Level 1A Product Specific Metadata(TIR) (4/4)

No.	Group/Object Name	type*1	Description	
7	5	StandardDeviationOffset	double	Standard deviation offset value. (LSDOset, PSDOset) where, LSDOset: Line direction SD offset in along track direction. PSDOset: Pixel direction SD offset in cross track direction.
	6	Threshold	double	Threshold value. (CThld, LOThld, POThld, VOThld) where, CThld: Correction threshold LOThld: offset threshold in along track direction POThld: offset threshold in cross track direction VOThld: Vector offset threshold
8	TIRSTCInfo *5			This denotes the Short-Term Calibration (STC) Information of TIR data.
	TIRSTCInfoContainer(n) *2			n = 1: pre-STC n = 2: post-STC
	1	ShortTermCalInfo10(n) *2		The Short-Term Cal. Information of TIR Band 10.
	1	BlackBodyMean10(n) *2	double	Black body image data mean value for each TIR Band 10's detector. (mn ₁ , mn ₂ , ~, mn ₁₀)
	2	BlackBodyStd10(n) *2	double	Black body image data standard deviation value for each TIR Band 10's detector. (sd ₁ , sd ₂ , ~, sd ₁₀)
	2 ~ 5.2	For ShortTermCalInfo11~ShortTermCalInfo14 repeat the above items.		
	6	BlackBodyInfo(n) *2		The Black Body Temperature information.
	1	BlackBodyTempMean(n) *2	double	Mean value for each of five temperature group. (bbtm ₁ , bbtm ₂ , ~, bbtm ₅)
	2	BlackBodyTempStd(n) *2	double	Standard deviation value for each of five temperature group. (bbtsd ₁ , bbtsd ₂ , ~, bbtsd ₅)
	7	ChopperInfo(n) *2		The Chopper Temperatuer information.
1	ChopperTempMean(n) *2	double	Mean value for each of three temperature group. (ctmn ₁ , ctmn ₂ , ctmn ₃)	
2	ChopperTempStd(n) *2	double	Standard deviation value for each of three temperature group. (ctsd ₁ , ctsd ₂ , ctsd ₃)	

NOTES:

(*1) Object types used in Metadata are

- a. datetime: CCSDS A (UTC) Format
 - b. integer
 - c. double: the floating point value is rounded to the appropriate number
(6 digits after the decimal-point character).
 - d. string
- (*2) Object whose name followed by (n) has “class” attribute. It may repeat n-times.
- (*3) The information concerning the list of bad pixels apart from this attribute and is written to the separated attribute named “badpixelinformation”. Refer to the section 2.3.1.7, titled *Bad Pixel Information*.
- (*4) SCF Toolkit does not support exponential numbers correspond to the Third Numerical Representation (NR3) in ISO 6093, then this should be expressed as a quoted strings. Each number is represented by two sequences of decimal digits called the significant (i.e., mantissa) and exponent, separated by the ASCII character **E** (e.g. **Value**= (“+1.23E-1”, “-4.99E+2”).
- (*5) Item 8.1.1 through 8.7.2 do **NOT** exist for the data type of the source data product that stores ‘EDS’ (Refer to the item 8 in the table 2.3.1-2).

2.3.1.7 Bad Pixel Information

(1) Indexes of Objects

The Object list of Bad Pixel Information is shown in Table 2.3.1-7. Bad Pixel Information attributes are written to the HDF file attribute named “**badpixelinformation**”.

Bad Pixel Information includes product specific attributes, i.e. not associated with DID311.

(In Table 2.3.1-7, group names are written in **Bold** characters. A group contains a set of objects that all have a similar theme.)

Bad Pixel information is set for every band individually, and the mandatory attributes for their objects are flagged as “FALSE”. When the band image has no bad pixel, the corresponding bad pixel information is not set in this attribute. So, in case that all bands have no bad pixel, this specific attribute will not appear in the HDF-EOS attribute.

Table 2.3.1-7 List of Object in Bad Pixel Information (1/2)

No.	Group/Object Name	type*1	Description	
1	Band1Information		This group contains the information about the bad pixels with respect to the Level 1A VNIR Band-1 image.	
	1	NumberOfElement1	integer	The number of elements of the list of bad pixels
	2	ListofBadPixels1		This group contains the list of bad pixels.
		ListofBadPixels1Container(n) *2		
	1	DirectionofBadPixel1(n)* 2	string	The direction of bad pixel segment. ‘C’ = cross-track ‘A’ = along-track
2	BadPixelSegments1(n)*2	integer	Location information for each bad pixel element. (LPNo, FPL, LPL) where, LPNo: The line number in cross-track segment (or the pixel number in along-track segment) including BPS. FPL: First pixel (or line) number of BPS. LPL: Last pixel (or line) number of BPS.	
3	CauseofBadPixel1(n)*2	string	The cause of bad data: ‘M’: Data missing*3 ‘D’: Damaged Detector	
2 ~ 2.2.3	For next Band2Information , repeat the above items (1 through 1.2.3).			
3 ~ 3.2.3	For next Band3NInformation , repeat the above items (1 through 1.2.3).			
4 ~ 4.2.3	For next Band3BInformation , repeat the above items (1 through 1.2.3).			
5 ~ 5.2.3	For next Band4Information , repeat the above items (1 through 1.2.3).			
6 ~ 6.2.3	For next Band5Information , repeat the above items (1 through 1.2.3).			
7 ~ 7.2.3	For next Band6Information , repeat the above items (1 through 1.2.3).			
8 ~ 8.2.3	For next Band7Information , repeat the above items (1 through 1.2.3).			
9 ~ 9.2.3	For next Band8Information , repeat the above items (1 through 1.2.3).			
10 ~ 10.2.3	For next Band9Information , repeat the above items (1 through 1.2.3).			

Table 2.3.1-7 List of Object in Bad Pixel Information (2/2)

No.	Group/Object Name	type*1	Description
11 ~ 11.2.3	For next Band10Information ,		repeat the above items (1 through 1.2.3).
12 ~ 12.2.3	For next Band11Information ,		repeat the above items (1 through 1.2.3).
13 ~ 13.2.3	For next Band12Information ,		repeat the above items (1 through 1.2.3).
14 ~ 14.2.3	For next Band13Information ,		repeat the above items (1 through 1.2.3).
15 ~ 15.2.3	For next Band14Information ,		repeat the above items (1 through 1.2.3).

NOTES:

(*1) Object types used in Metadata are

a. datetime: CCSDS A (UTC) Format

b. integer

c. double: the floating point value is rounded to the appropriate number
(6 digits after the decimal-point character).

d. string

(*2) Object whose name followed by (n) has “class” attribute. It may repeat n-times.

(*3) Just in case of SWIR, ‘Me’ for even pixel and ‘Mo’ for odd pixel.

This page intentionally left blank.

2.3.2 Cloud Coverage Table

(1) Description

Cloud coverage table is available for Level 1A Product corresponding to each ASTER Observation (OBS) modes.

(2) Characteristics

- a) Data model: SDS (2 Dimensional Array)
- b) Object Name: **Cloud_Coverage_Table**
- c) Format: Refer to Table 2.3.2-1
- d) Contents: each element is 1 byte data, indicates **clear** (= **0**) or **cloudy** (= **1**) for the rectangular area (the definition of those area is shown in Note 1 and Note 2 below).

Table 2.3.2-1 Size of Cloud Coverage Data

Reference Coordinates	Dimension Size	Variable Type
SWIR ^{*1}	[n][104] ^{*2}	UINT8
VNIR	[n][100] ^{*2}	UINT8
TIR	[n][117] ^{*2}	UINT8

(*1) In case that the strip observation mode is “VST+T” or “ST+T” and only TIR data is included in the product(i.e., SensorShortName contains only “ASTER_TIR” and ASTERObservationMode identifies VST or ST mode), the reference coordinate for the cloud coverage table will be ‘SWIR’ (not ‘TIR’). See the section 1.5, titled *Strip Observation Mode*.

(*2) Cloud coverage table is entered in the order with [line][pixel]. Line size is depending on a processing scene. (e.g., n: nominal value 106 in case of SWIR)

Note 1: Reference Coordinates will change depending on condition of observation.

- a) In nominal case, the lattice coordinates of SWIR Geometric Correction Table (GCT) is used as center of evaluation rectangle.
- b) If SWIR data is not available, the lattice coordinate of VNIR GCT will be used as center instead.
- c) If both SWIR and VNIR data are not available, the lattice coordinate of TIR GCT will be used.

Note 2: Evaluation area size is shown as follows.

Reference Coordinate	SWIR	VNIR	TIR
Evaluation area size	20L*20P	41L*41P	6L*6P

2.3.3 Ancillary Data

(1) Description

Ancillary Data includes the satellite's orbit/attitude data, and their time tags. Since ancillary data appended to onboard instrument data are updated once per major cycle time (1.024 sec), in order to match with the scene observation time, an extra number of ancillary data will be extracted and provided. To ensure the conformity with instrument data, the time data which represents the ancillary data updating time(UTC) is assigned to the leading ancillary data, and called Time Tag. This is used as control data for extracted Image Data.

(2) Characteristics

Ancillary Data Group contains a series of Ancillary Data Records through the use of Vgroup API.

vgroup name: **Ancillary_Data**
class: **Ancillary**

Each record of Ancillary Data has following characteristics.

- a) Data model: Vdata
- b) Object Name: **Ancillary_Data**
- c) Class Name: Anc_Record.*n* (*n*: Record count number -- 12 ~ 31 records)
- d) Format and contents: Table 2.3.3-1 shows the format and the contents of Ancillary Data. Some Ancillary Data contains multiple entries per field. Order that is the number of components in a field is also shown in Table 2.3.3-1.

Table 2.3.3-1 Format of Ancillary Data (1/2)

Field Name	Order	Variable Size	Description
Time_Tag	4	UINT16	Time Tag (UTC): Spacecraft Time Format
Primary_Header	6	UINT8	CCSDS Primary Packet Header for downlink, used for ground routing and processing.
Secondary_Header	8	UINT8	This field is part of the secondary header of the packet for downlink. Bit 0: Secondary Header ID Flag (always a data zero) Bit 1-63: Time Stamp -- Epoch of the data in the ancillary data message. Spacecraft clock time in CCSDS Day-Segmented Format. The code epoch is January 1, 1958.
Flag_Byte	1	UINT8	Flag Byte -- Flags for ground data processing control. First (most significant) bit is the "quick look" bit. Other bits are reserved and will contain data zero. This field is part of the secondary header of the packet for downlink.
Time_Conversion	3	INT8	Time Conversion -- Estimated difference between UTC and the Spacecraft Clock. This may be added to the Spacecraft Clock time to derive UTC time.
Position	3	INT32	Spacecraft Position (x, y, z) -- Estimated position of the spacecraft, expressed in Earth Centered Inertial frame (mean Equator and Equinox of J2000).
Velocity	3	INT32	Spacecraft Velocity (x, y, z) -- Estimated velocity of the spacecraft, expressed in Earth Centered Inertial frame (mean Equator and Equinox of J2000).
Attitude_Angle	3	INT16	Attitude Angle (Roll, Pitch, Yaw) -- The estimated attitude of the spacecraft, expressed in the Orbital Reference frame.
Attitude_Rate	3	INT16	Attitude Rate (Roll, Pitch, Yaw) -- The estimated attitude rate of the spacecraft, expressed in the Orbital Reference frame.

Table 2.3.3-1 Format of Ancillary Data (2/2)

Field Name	Order	Variable Size	Description
Magnetic_Coil	3	INT8	Magnetic Coil Current (x, y, z) -- Currents flowing in each of the magnetic torque coils used for Spacecraft momentum unloading.
Solar_Array	1	UINT8	Solar Array Current -- Current flowing from the Spacecraft solar array.
Solar_Position	3	INT8	Solar Position (x, y, z) -- Components of unit vector, expressed in the Spacecraft Reference frame, pointing in the direction of the Sun.
Moon_Position	3	INT8	Moon Position (x, y, z) -- Components of the unit vector, expressed in the Spacecraft Reference frame, pointing in the direction of the Moon.

Note 1: Resolution and Range are shown as follows.

Ancillary Data	Resolution	Range
Primary Header	N/A	N/A
Secondary Header	N/A	N/A
Time Stamp	1 μ sec	1958-2047
Flag Byte	N/A	N/A
Time Conversion	1 μ sec	$\pm 8.3 \cdot 10^6 \mu$ sec
Spacecraft Position	0.125 m	$\pm 268 \cdot 10^6$ m
Spacecraft Velocity	$244 \cdot 10^{-6}$ m/s	$\pm 524 \cdot 10^3$ m/s
Attitude Angle	1.0 arcsec	± 2048 arcsec
Attitude Rate	0.5 arcsec/sec	± 1024 arcsec/sec
Magnetic Coil Current	$15.6 \cdot 10^{-3}$ A	± 2.0 A
Solar Array Current	1.0 A	0-256 A
Solar Position	$7.8 \cdot 10^{-3}$	± 1
Moon Position	$7.8 \cdot 10^{-3}$	± 1

2.3.4 VNIR Group

2.3.4.1 Overview

VNIR Group contains an SDS and a series of Swath Objects through the use of the Vgroup API. Vgroup name that establishes access to a Vgroup is as follows.

vgroup name: **VNIR**
class: **1A**

2.3.4.2 VNIR Band 1 Swath

(1) Structure

A single swath contains any number of Tables and Multidimensional Arrays. There is however one type of information that is special: geolocation information. In a swath, geolocation information is stored as a series of arrays. We require that every swath contain some geolocation component.

The data itself is stored in multidimensional arrays in the swath. The only limitation is that the first dimension is the Track dimension. Each Band is stored as separate Swath structure, one per geolocation object.

Consider Figure 2.3.4-1, which is represent of a swath consisting of a combination of 2D and 3D data arrays, a series of 2D geolocation arrays, a series of data tables, and a single 1D geolocation tables.

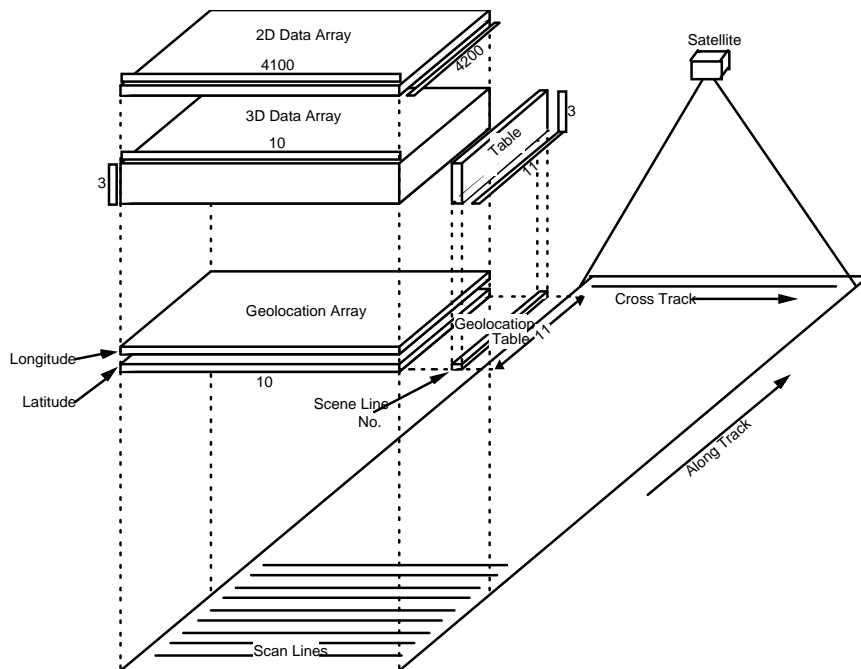

Figure 2.3.4-1 Conceptual View of Example of Swath

(2) Characteristics

Table 2.3.4-1 shows the List of data items in VNIR Band 1 Swath.

a) Data model: Swath

b) Object Name: **VNIR_Band1**

c) Format: Table 2.3.4-1 shows the contents of Swath Object. Table 2.3.4-2 shows the format of them.

Table 2.3.4-1 List of data items in Level 1A VNIR Band 1 Swath

No.	Field Name	Type	Unit	Comments
1.	Latitude	Geolocation Array	deg.	geocentric latitude: decimal degree on range [-90.0, 90.0]
2.	Longitude	Geolocation Array	deg.	geocentric longitude: decimal degree on range [-180.0, 180.0]
3.	SceneLineNumber	Geolocation Table	line	coordinates based on the strip image
4.	LatticePoint	3D Data Array	pixel, line	lattice point coordinates (pixel, line) based on image data
5.	SightVector	3D Data Array	arcsec	line of sight vector (roll, pitch, yaw) in orbital reference frame
6.	SatellitePosition	Data Table	m	satellite position vector (x, y, z) at ECR
7.	SatelliteVelocity	Data Table	m/sec	satellite velocity vector (x, y, z) at ECR
8.	AttitudeAngle	Data Table	arcsec	satellite attitude angle (roll, pitch, yaw) in orbital reference frame
9.	AttitudeRate	Data Table	arcsec/sec	satellite attitude angular velocity (roll, pitch, yaw)
10.	ObservationTime	Data Table	N/A	observation time of this lattice point (UTC) Format: Spacecraft Time Format
11.	ImageData	2D Data Array	N/A	Level 1A spectral band image data
12.	RadiometricCorrTable	2D Data Array	N/A	radiometric correction coefficients of equation: $L = A_v * V / G_v + D_v$ The order of the last dimension of these coefficients is (Dv, Av, Gv). The order of the first dimension corresponds to the detector number.

Table 2.3.4-2 Format of data items in VNIR Band 1 Swath

Field Name	Dimension Size	Variable Type	Remarks
Latitude	[n][11]	DOUBLE	geolocation field (Array)
Longitude	[n][11]	DOUBLE	geolocation field (Array)
SceneLineNumber	[n]	INT32	geolocation field (Table)
LatticePoint	[n][11][2]	INT32	mapping to geolocation array
SightVector	[n][11][3]	DOUBLE	mapping to geolocation array
SatellitePosition	[n][3]	DOUBLE	mapping to geolocation table
SatelliteVelocity	[n][3]	DOUBLE	mapping to geolocation table
AttitudeAngle	[n][3]	DOUBLE	mapping to geolocation table
AttitudeRate	[n][3]	DOUBLE	mapping to geolocation table
ObservationTime	[n][4]	UINT16	mapping to geolocation table
ImageData	[4200][4100]	UINT8	mapping to geolocation array
RadiometricCorrTable	[4100][3]	FLOAT	non-mapping to geolocation array

n: revised to accommodate a processing scene (12: nominal).

(3) Block Size

Block size is shown as follows.

Type	Block size
Geolocation Array	400 lines * 410 pixels
Geolocation Table	400 lines

2.3.4.3 VNIR Band 2 Swath

(1) Structure

Refer to the section 2.3.4.2, titled *VNIR Band 1 Swath*.

(2) Characteristics

The contents of VNIR Band 2 Swath are similar to the items in Table 2.3.4-1.

a) Data model: Swath

b) Object Name: **VNIR_Band2**

c) Format: The format of each item in Swath object is similar to the one in Table 2.3.4-2.

2.3.4.4 VNIR Band 3N Swath

(1) Structure

Refer to the section 2.3.4.2, titled *VNIR Band 1 Swath*.

(2) Characteristics

The contents of VNIR Band 3N Swath are similar to the items in Table 2.3.4-1.

a) Data model: Swath

b) Object Name: **VNIR_Band3N**

c) Format: The format of each item in Swath object is similar to the one in Table 2.3.4-2.

2.3.4.5 VNIR Band 3B Swath

(1) Structure

Refer to the section 2.3.4.2, titled *VNIR Band 1 Swath*.

(2) Characteristics

The contents of VNIR Band 3B Swath are similar to the items in Table 2.3.4-1.

a) Data model: Swath

b) Object Name: **VNIR_Band3B**

c) Format: Table 2.3.4-3 shows the format of one the contents of Swath Object.

Table 2.3.4-3 Format of data items in VNIR Band 3B Swath

Field Name	Dimension Size	Variable Type	Remarks
Latitude	[n][11]	DOUBLE	geolocation field (Array)
Longitude	[n][11]	DOUBLE	geolocation field (Array)
SceneLineNumber	[n]	INT32	geolocation field (Table)
LatticePoint	[n][11][2]	INT32	mapping to geolocation array
SightVector	[n][11][3]	DOUBLE	mapping to geolocation array
SatellitePosition	[n][3]	DOUBLE	mapping to geolocation table
SatelliteVelocity	[n][3]	DOUBLE	mapping to geolocation table
AttitudeAngle	[n][3]	DOUBLE	mapping to geolocation table
AttitudeRate	[n][3]	DOUBLE	mapping to geolocation table
ObservationTime	[n][4]	UINT16	mapping to geolocation table
ImageData	[5400][5000]	UINT8	mapping to geolocation array
RadiometricCorrTable	[5000][3]	FLOAT	non-mapping to geolocation array

n: revised to accommodate a processing scene (15: nominal).

(3) Block Size

Block size is shown as follows.

Type	Block size
Geolocation Array	400 lines * 500 pixels
Geolocation Table	400 lines

2.3.4.6 VNIR Supplement Data

(1) Description

VNIR Supplement Data contains VNIR status data, calibration data, pointing angles, etc.

(2) Characteristics

a) Data model: SDS (2 Dimensional Array)

b) Object Name: **VNIR_Supplement**

c) Format: Dimension size and variable type are as follows. Table 2.3.4-4 shows the contents of Supplement Data with relation to each column of the last dimension.

Dimension Size	Variable Type
[n][58]	UINT8

**n: revised to accommodate a record count number.
(9600: nominal)**

Table 2.3.4-4 Format of VNIR Supplement Data (1/2)

No.*1	Description
0	Time Tag (UTC): Spacecraft Time Format (Time Tag is assigned to the leading supplement data to ensure the conformity with instrument data.)
1	
2	
3	
4	
5	
6	
7	
8	Band 1 Detector Temperature
9	Band 2 Detector Temperature
10	Band 3N Detector Temperature
11	Band 3B Detector Temperature
12	Calibration Lamp A Temperature
13	Calibration Lamp B Temperature
14	Monitor Amp. Temperature
15	Photodiode 1 Temperature
16	Photodiode 2A Temperature
17	Photodiode 2B Temperature
18	VSP 1 Temperature
19	VSP 2 Temperature
20	VEL Base Plate Temperature
21	Nadir Telescope Temperature 1
22	Nadir Telescope Temperature 2
23	Nadir Telescope Temperature 3
24	Preamp 2 Temperature
25	Backward Telescope Temperature 2
26	Backward Telescope Temperature 3
27	VPS Lamp Power Supply Voltage
28	Photodiode 1A Output
29	Photodiode 1B Output
30	Photodiode 2A Output
31	Photodiode 2B Output
32	Electric Calibration Voltage.1
33	Electric Calibration Voltage.2
34	Electric Calibration Voltage.3

Table 2.3.4-4 Format of VNIR Supplement Data (2/2)

No.*1	Description
35	Electric Calibration Voltage.4
36	VSP1 APS Vol. +10V
37	VSP1 APS Vol. -10V
38	Pointing Angle 1
39	Pointing Angle 2
40	Initial Extract Address 1
41	Initial Extract Address 2
42	Spare
43	Spare
44	Bit-0: OPE, Optical/Electric Calibration Selection Bit-1: Band 3 A/B Selection Bit-2,3: Band 3 Gain Selection (Bit-3, Bit-2) Low=(0,1), Normal=(0,0), High=(1,0) Bit-4,5: Band 2 Gain Selection (Bit-5, Bit-4) Low=(0,1), Normal=(0,0), High=(1,0) Bit-6,7: Band 1 Gain Selection (Bit-7, Bit-6) Low=(0,1), Normal=(0,0), High=(1,0)
45	Bit-0: Calibration Lamp A/B Selection Bit-1: PS1 On/Off Bit-2: PS3 On/Off Bit-3: Table Cancel On/Off Bit-4: PS4 On/Off Bit-5: Spare Bit-6: Spare Bit-7: Spare
46	Spare
47	Spare
48	Spare
49	Spare
50	Spare
51	Spare
52	Spare
53	Spare
54	Spare
55	Spare
56	Spare
57	Spare

NOTES:

(*1) 'No.' expresses the relative position in the last dimension. The dimension is entered in C order ('0' origin).

2.3.5 SWIR Group

2.3.5.1 Overview

SWIR Group contains an SDS and a series of Swath Objects through the use of the Vgroup API. Vgroup name that establishes access to a Vgroup is as follows.

vgroup name: **SWIR**
class: **1A**

2.3.5.2 SWIR Band 4 Swath

(1) Structure

Refer to the section 2.3.4.2, titled *VNIR Band 1 Swath*.

(2) Characteristics

Table 2.3.5-1 shows the List of data items in SWIR Band 4 Swath.

a) Data model: Swath

b) Object Name: **SWIR_Band4**

c) Format: Table 2.3.5-1 shows the contents of Swath Object. Table 2.3.5-2 shows the format of them.

Table 2.3.5-1 List of data items in Level 1A SWIR Band 4 Swath

No.	Field Name	Type	Unit	Comments
1.	Latitude	Geolocation Array	deg.	geocentric latitude: decimal degree on range [-90.0, 90.0]
2.	Longitude	Geolocation Array	deg.	geocentric longitude: decimal degree on range [-180.0, 180.0]
3.	SceneLineNumber	Geolocation Table	line	coordinates based on the strip image
4.	LatticePoint	3D Data Array	pixel, line	Lattice point coordinates (pixel, line) based on image data
5.	SightVector	3D Data Array	arcsec	line of sight vector (roll, pitch, yaw) in orbital reference frame
6.	IntertlescopeOffset	3D Data Array	deg.	angular displacements of SWIR in geocentric latitude and longitude as compared to VNIR.
7.	ParallaxOffset	3D Data Array	deg.	parallax correction (Δlat , $\Delta long$)
8.	Evaluation	2D Data Array	N/A	1: Image matching 2: using DEM
9.	SatellitePosition	Data Table	m	satellite position vector (x, y, z) at ECR
10.	SatelliteVelocity	Data Table	m/sec	satellite velocity vector (x, y, z) at ECR
11.	AttitudeAngle	Data Table	arcsec	satellite attitude angle (roll, pitch, yaw) in orbital reference frame
12.	AttitudeRate	Data Table	arcsec/sec	satellite attitude angular velocity (roll, pitch, yaw)
13.	ObservationTime	Data Table	N/A	observation time of this lattice point Format: Spacecraft Time Format
14.	ImageData	2D Data Array	N/A	Level 1A spectral band image data
15.	RadiometricCorrTable	2D Data Array	N/A	Radiometric correction coefficients of equation: $L = \mathbf{A}_s * \mathbf{V} / \mathbf{G}_s + \mathbf{D}_s$ The order of the last dimension of these coefficients is (Ds, As, Gs). The order of the first dimension corresponds to the detector number.

Table 2.3.5-2 Format of data items in SWIR Band 4 Swath

Field Name	Dimension Size	Variable Type	Remarks
Latitude	[n][104]	DOUBLE	geolocation field (Array)
Longitude	[n][104]	DOUBLE	geolocation field (Array)
SceneLineNumber	[n]	INT32	geolocation field (Table)
LatticePoint	[n][104][2]	INT32	mapping to geolocation array
SightVector	[n][104][3]	DOUBLE	mapping to geolocation array
IntertelescopeOffset	[n][104][2]	FLOAT	mapping to geolocation array
ParallaxOffset	[n][104][2]	FLOAT	mapping to geolocation array
Evaluation	[n][104]	INT32	mapping to geolocation array
SatellitePosition	[n][3]	DOUBLE	mapping to geolocation table
SatelliteVelocity	[n][3]	DOUBLE	mapping to geolocation table
AttitudeAngle	[n][3]	DOUBLE	mapping to geolocation table
AttitudeRate	[n][3]	DOUBLE	mapping to geolocation table
ObservationTime	[n][4]	UINT16	mapping to geolocation table
ImageData	[2100][2048]	UINT8	mapping to geolocation array
RadiometricCorrTable	[2048][3]	FLOAT	non-mapping to geolocation array

n: revised to accommodate a processing scene (106: nominal).

(3) Block Size

Block size is shown as follows.

Type	Block size
Geolocation Array	20 lines * 20 pixels
Geolocation Table	20 lines

2.3.5.3 SWIR Band 5 Swath

(1) Structure

Refer to the section 2.3.4.2, titled *VNIR Band 1 Swath*.

(2) Characteristics

The contents of SWIR Band 5 Swath are similar to the items in Table 2.3.5-1.

a) Data model: Swath

b) Object Name: **SWIR_Band5**

c) Format: The format of each item in Swath object is similar to the one in Table 2.3.5-2.

2.3.5.4 SWIR Band 6 Swath

(1) Structure

Refer to the section 2.3.4.2, titled *VNIR Band 1 Swath*.

(2) Characteristics

The contents of SWIR Band 6 Swath are similar to the items in Table 2.3.5-1.

a) Data model: Swath

b) Object Name: **SWIR_Band6**

c) Format: The format of each item in Swath object is similar to the one in Table 2.3.5-2.

2.3.5.5 SWIR Band 7 Swath

(1) Structure

Refer to the section 2.3.4.2, titled *VNIR Band 1 Swath*.

(2) Characteristics

The contents of SWIR Band 7 Swath are similar to the items in Table 2.3.5-1.

a) Data model: Swath

b) Object Name: **SWIR_Band7**

c) Format: The format of each item in Swath object is similar to the one in Table 2.3.5-2.

2.3.5.6 SWIR Band 8 Swath

(1) Structure

Refer to the section 2.3.4.2, titled *VNIR Band 1 Swath*.

(2) Characteristics

The contents of SWIR Band 8 Swath are similar to the items in Table 2.3.5-1.

a) Data model: Swath

b) Object Name: **SWIR_Band8**

c) Format: The format of each item in Swath object is similar to the one in Table 2.3.5-2.

2.3.5.7 SWIR Band 9 Swath

(1) Structure

Refer to the section 2.3.4.2, titled *VNIR Band 1 Swath*.

(2) Characteristics

The contents of SWIR Band 9 Swath are similar to the items in Table 2.3.5-1.

a) Data model: Swath

b) Object Name: **SWIR_Band9**

c) Format: The format of each item in Swath object is similar to the one in Table 2.3.5-2.

2.3.5.8 SWIR Supplement Data

(1) Description

SWIR Supplement Data contains SWIR status data, calibration data, pointing angles, etc.

(2) Characteristics

- a) Data Model: SDS (2 Dimensional Array)
- b) Object Name: **SWIR_Supplement**
- c) Format: Dimension size and variable type are as follows. Since SWIR Supplement Data is updated once per cycle time (4.398msec), Increment of frame number is attended on this update. Table 2.3.5-3 shows the contents of each entry. Table 2.3.5-4 shows the contents of Supplement Data with relation to each column of the last dimension. Table 2.3.5-5~8 show the contents of Supplement Data in detail.

Dimension Size	Variable Type
[n][49]	UINT8

**n: revised to accommodate a record count number.
(2510: nominal)**

Table 2.3.5-3 Contents of SWIR Supplement Data

Frame Number	Contents of the Entries
0	all of synchronous code, frame number, and reserved field and Major Frame No. 0 & 1 (MF-0,1) from WORD#38 to WORD#53 in Table 2.3.5-4~8.
1	all of synchronous code, frame number, and reserved field and Major Frame No. 2 & 3 (MF-2,3) from WORD#38 to WORD#53 in Table 2.3.5-4~8.
2	all of synchronous code, frame number, and reserved field and Major Frame No. 4 & 5 (MF-4,5) from WORD#38 to WORD#53 in Table 2.3.5-4~8.
3	all of synchronous code, frame number, and reserved field and Major Frame No. 6 & 7 (MF-6,7) from WORD#38 to WORD#53 in Table 2.3.5-4~8.
...	write following entries repeatedly concerning above four frames.

Table 2.3.5-4 Format of SWIR Supplement Data (1/4)

No.*1	Description
0	Time Tag: Spacecraft Time Format
1	
2	
3	
4	
5	
6	
7	
8	Synchronous Code (6DE2B846)
9	
10	
11	
12	Frame Number (sequential number from 0 to $2^{24}-1$)
13	
14	

Table 2.3.5-4 Format of SWIR Supplement Data (2/4)

No.*1	Description
15	WORD#38 MF-0: Optics monitor voltage A MF-2: Optics monitor voltage A MF-4: Optics monitor voltage A MF-6: Optics monitor voltage A
16	WORD#38 MF-1: Cooler current 3 MF-3: Cooler current 3 MF-5: Cooler current 3 MF-7: Cooler current 3
17	WORD#39 MF-0: Spare MF-2: Spare MF-4: Spare MF-6: Spare
18	WORD#39 MF-1: Cooler current 4 MF-3: Cooler current 4 MF-5: Cooler current 4 MF-7: Cooler current 4
19	WORD#40 MF-0: Optics monitor voltage B MF-2: Optics monitor voltage B MF-4: Optics monitor voltage B MF-6: Optics monitor voltage B
20	WORD#40 MF-1: Detector temperature (NARROW) MF-3: Detector temperature (NARROW) MF-5: Detector temperature (NARROW) MF-7: Detector temperature (NARROW)
21	WORD#41 MF-0: Spare MF-2: Spare MF-4: Spare MF-6: Spare
22	WORD#41 MF-1: TLM/CMD circuit reference voltage 1 MF-3: TLM/CMD circuit reference voltage 1 MF-5: TLM/CMD circuit reference voltage 1 MF-7: TLM/CMD circuit reference voltage 1
23	WORD#42 MF-0: Cooler current 1 MF-2: Cooler current 1 MF-4: Cooler current 1 MF-6: Cooler current 1
24	WORD#42 MF-1: TLM/CMD circuit reference voltage 2 MF-3: TLM/CMD circuit reference voltage 2 MF-5: TLM/CMD circuit reference voltage 2 MF-7: TLM/CMD circuit reference voltage 2
25	WORD#43 MF-0: Cooler current 2 MF-2: Cooler current 2 MF-4: Cooler current 2 MF-6: Cooler current 2

Table 2.3.5-4 Format of SWIR Supplement Data (3/4)

No.*1	Description
26	WORD#43 MF-1: TLM/CMD circuit reference voltage 3 MF-3: TLM/CMD circuit reference voltage 3 MF-5: TLM/CMD circuit reference voltage 3 MF-7: TLM/CMD circuit reference voltage 3
27	WORD#44 See Table 2.3.5-5 (MF-0, 2, 4, 6)
28	WORD#44 See Table 2.3.5-5 (MF-1, 3, 5, 7)
29	WORD#45 MF-0: See Table 2.3.5-6 MF-2: See Table 2.3.5-6 MF-4: See Table 2.3.5-6 MF-6: See Table 2.3.5-6
30	WORD#45 MF-1: Drive plus width MF-3: Drive plus width MF-5: Drive plus width MF-7: Drive plus width
31	WORD#46 MF-0: A/D reference voltage (Band 4) MF-2: Detector Dewar temperature MF-4: Collector module temperature 1 MF-6: Spare
32	WORD#46 MF-1: Calibration lamp voltage A MF-3: Barrel STR temperature MF-5: Electrical circuit temperature 1 (DRV) MF-7: Spare
33	WORD#47 MF-0: A/D reference voltage (Band 5) MF-2: Radiator temperature (Inner) MF-4: Collector module temperature 2 MF-6: Spare
34	WORD#47 MF-1: Calibration lamp voltage B MF-3: INE Mount temperature MF-5: Electrical circuit temperature 2 (PRO) MF-7: Spare
35	WORD#48 MF-0: A/D reference voltage (Band 6) MF-2: Radiator temperature A MF-4: Detector preamp/dewar temperature A MF-6: Spare
36	WORD#48 MF-1: Detector temperature (Wide) MF-3: Electrical circuit 1 temperature MF-5: Electrical circuit temperature 3A (CT) MF-7: Spare
37	WORD#49 MF-0: A/D reference voltage (Band 7) MF-2: Cover temperature 2A (-X) MF-4: Pointing mechanism temperature MF-6: Spare

Table 2.3.5-4 Format of SWIR Supplement Data (4/4)

No.*1	Description
38	WORD#49 MF-1: Motor amplitude MF-3: Electrical circuit 2 temperature MF-5: Electrical circuit temperature 4 (CAL) MF-7: Spare
39	WORD#50 MF-0: A/D reference voltage (Band 8) MF-2: Cover temperature 1A (+X) MF-4: Cooler temperature 1A (COMP) MF-6: Spare
40	WORD#50 MF-1: Spare MF-3: Pointing mechanism temperature 1 (MTR) MF-5: Optics monitor temperature A MF-7: Spare
41	WORD#51 MF-0: A/D reference voltage (Band 9) MF-2: Cover temperature 3A (+Z) MF-4: Cooler temperature 2A (C-FNG) MF-6: Spare
42	WORD#51 MF-1: Spare MF-3: Calibration lamp temperature MF-5: Optics monitor temperature B MF-7: Spare
43	WORD#52 MF-0: Drive plus number 1 MF-2: See Table 2.3.5-7 MF-4: See Table 2.3.5-7 MF-6: Spare
44	WORD#52 MF-1: See Table 2.3.5-7 MF-3: See Table 2.3.5-7 MF-5: Spare MF-7: Spare
45	WORD#53 MF-0: Drive plus number 2 MF-2: See Table 2.3.5-8 MF-4: See Table 2.3.5-8 MF-6: Spare
46	WORD#53 MF-1: See Table 2.3.5-8 MF-3: See Table 2.3.5-8 MF-5: Spare MF-7: Spare
47	reserved
48	reserved

NOTES:

(*1) 'No.' expresses the relative position in the last dimension. The dimension is entered in C order ('0' origin).

Table 2.3.5-5 WORD#44

Major Frame	Contents
0, 2, 4, 6	Bit-0: Pointing mirror encoder 1 Bit-1: Pointing mirror encoder 1 Bit-2: Pointing mirror encoder 1 Bit-3: Pointing mirror encoder 1 Bit-4: Pointing mirror encoder 1 Bit-5: Pointing mirror encoder 1 Bit-6: Pointing mirror encoder 1 Bit-7: Pointing mirror encoder 1
1, 3, 5, 7	Bit-0: Pointing mirror encoder 3 Bit-1: Mirror position status Bit-2: Mirror position status Bit-3: Mirror position limit status Bit-4: Limit ENA/DISA Bit-5: Pointing motor ENA/DISA Bit-6: Encoder on/off Bit-7: Motor rotation CW/CCW

Table 2.3.5-6 WORD#45

Major Frame	Contents
0, 2, 4, 6	Bit-0: Pointing mirror encoder 2 Bit-1: Pointing mirror encoder 2 Bit-2: Pointing mirror encoder 2 Bit-3: Pointing mirror encoder 2 Bit-4: Pointing mirror encoder 2 Bit-5: Pointing mirror encoder 2 Bit-6: Pointing mirror encoder 2 Bit-7: Pointing mirror encoder 2

Table 2.3.5-7 WORD#52 (1/2)

Major Frame	Contents
1	Bit-0: Band 4 gain status Bit-1: Band 4 gain status Bit-2: Band 5 gain status Bit-3: Band 5 gain status Bit-4: Band 6 gain status Bit-5: Band 6 gain status Bit-6: Spare Bit-7: Spare
2	Bit-0: DIG SIG PROC PWR Bit-1: TML/CMD PWR on/off Bit-2: Analog circuit power on/off Bit-3: Spare Bit-4: Spare Bit-5: Spare Bit-6: Pointing CIR PWR Bit-7: Spare

Table 2.3.5-7 WORD#52 (2/2)

Major Frame	Contents
3	Bit-0: THER CIR PWR Bit-1: Spare Bit-2: Spare Bit-3: Heater 3 on/off Bit-4: Heater 4 on/off Bit-5: Heater 5 on/off Bit-6: Spare Bit-7: Spare
4	Bit-0: Party flag status Bit-1: ERR CMD DIS status Bit-2: ERR CMD DIS status Bit-3: ERR CMD DIS status Bit-4: ERR CMD DIS status Bit-5: ERR CMD DIS status Bit-6: Spare Bit-7: Spare

Table 2.3.5-8 WORD#53

Major Frame	Contents
1	Bit-0: Band 7 gain status Bit-1: Band 7 gain status Bit-2: Band 8 gain status Bit-3: Band 8 gain status Bit-4: Band 9 gain status Bit-5: Band 9 gain status Bit-6: Spare Bit-7: Spare
2	Bit-0: Calibration lamp power on/off Bit-1: Calibration lamp A/B selection Bit-2: Spare Bit-3: Spare Bit-4: Spare Bit-5: Spare Bit-6: Spare Bit-7: Spare
3	Bit-0: CLR motor amplitude status Bit-1: CLR motor amplitude status Bit-2: Spare Bit-3: Spare Bit-4: Detector temperature set status Bit-5: Detector temperature set status Bit-6: Spare Bit-7: Spare
4	Bit-0: Motor position status Bit-1: Motor position status Bit-2: Spare Bit-3: Spare Bit-4: Spare Bit-5: Spare Bit-6: Spare Bit-7: Spare

2.3.6 TIR Group

2.3.6.1 Overview

TIR Group contains a Vgroup and a series of Swath Objects through the use of the Vgroup API. Vgroup name that establishes access to a Vgroup is as follows.

vgroup name: **TIR**
class: **1A**

2.3.6.2 TIR Band 10 Swath

(1) Structure

Refer to the section 2.3.4.2, titled *VNIR Band 1 Swath*.

(2) Characteristics

Table 2.3.6-1 shows the List of data items in TIR Band 10 Swath.

a) Data model: Swath

b) Object Name: **TIR_Band10**

c) Format: Table 2.3.6-1 shows the contents of Swath Object. Table 2.3.6-2 shows the format of them.

Table 2.3.6-1 List of data items in Level 1A TIR Band 10 Swath

No.	Field Name	Type	Unit	Comments
1.	Latitude	Geolocation Array	deg.	geocentric latitude: decimal degree on range [-90.0, 90.0]
2.	Longitude	Geolocation Array	deg.	geocentric longitude: decimal degree on range [-180.0, 180.0]
3.	SceneLineNumber	Geolocation Table	line	coordinates based on the strip image
4.	LatticePoint	3D Data Array	pixel, line	Lattice point coordinates (pixel, line) based on image data
5.	SightVector	3D Data Array	arcsec	line of sight vector (roll, pitch, yaw) in orbital reference frame
6.	IntertlescopeOffset	3D Data Array	deg.	angular displacements of TIR in geocentric latitude and longitude as compared to VNIR.
7.	SatellitePosition	Data Table	m	satellite position vector (x, y, z) at ECR
8.	SatelliteVelocity	Data Table	m/sec	satellite velocity vector (x, y, z) at ECR
9.	AttitudeAngle	Data Table	arcsec	satellite attitude angle (roll, pitch, yaw) in orbital reference frame
10.	AttitudeRate	Data Table	arcsec/sec	satellite attitude angular velocity (roll, pitch, yaw)
11.	ObservationTime	Data Table	N/A	observation time of this lattice point Format: Spacecraft Time Format
12.	InterpolationParameter	Data Table	pixel	deviation of start position of detectors in the cross-track direction between scans
13.	ImageData	2D Data Array	N/A	Level 1A spectral band image data
14.	RadiometricCorrTable	2D Data Array	N/A	Radiometric correction coefficients of equation: $L = C_0 + C_1 * V + C_2 * V^2$ The order of the last dimension of these coefficients is (C ₀ , C ₁ , C ₂). The order of the first dimension corresponds to the detector number.

Table 2.3.6-2 Format of data items in TIR Band 10 Swath

Field Name	Dimension Size	Variable Type	Remarks
Latitude	[n][11]	DOUBLE	geolocation field (Array)
Longitude	[n][11]	DOUBLE	geolocation field (Array)
SceneLineNumber	[n]	INT32	geolocation field (Table)
LatticePoint	[n][11][2]	INT32	mapping to geolocation array
SightVector	[n][11][3]	DOUBLE	mapping to geolocation array
IntertelescopeOffset	[n][11][2]	FLOAT	mapping to geolocation array
SatellitePosition	[n][3]	DOUBLE	mapping to geolocation table
SatelliteVelocity	[n][3]	DOUBLE	mapping to geolocation table
AttitudeAngle	[n][3]	DOUBLE	mapping to geolocation table
AttitudeRate	[n][3]	DOUBLE	mapping to geolocation table
ObservationTime	[n][4]	UINT16	mapping to geolocation table
InterpolationParameter	[n]	DOUBLE	mapping to geolocation table
ImageData	[700][700]	UINT16	mapping to geolocation array
RadiometricCorrTable	[10][3]	FLOAT	non-mapping to geolocation array

n: revised to accommodate a processing scene (11: nominal).

(3) Block Size

Block size is shown as follows.

Type	Block size
Geolocation Array	70 lines * 70 pixels
Geolocation Table	70 lines

2.3.6.3 TIR Band 11 Swath

(1) Structure

Refer to the section 2.3.4.2, titled *VNIR Band 1 Swath*.

(2) Characteristics

The contents of TIR Band 11 Swath are similar to the items in Table 2.3.6-1.

a) Data model: Swath

b) Object Name: **TIR_Band11**

c) Format: The format of each item in Swath object is similar to the one in Table 2.3.6-2.

2.3.6.4 TIR Band 12 Swath

(1) Structure

Refer to the section 2.3.4.2, titled *VNIR Band 1 Swath*.

(2) Characteristics

The contents of TIR Band 12 Swath are similar to the items in Table 2.3.6-1.

a) Data model: Swath

b) Object Name: **TIR_Band12**

c) Format: The format of each item in Swath object is similar to the one in Table 2.3.6-2.

2.3.6.5 TIR Band 13 Swath

(1) Structure

Refer to the section 2.3.4.2, titled *VNIR Band 1 Swath*.

(2) Characteristics

The contents of TIR Band 13 Swath are similar to the items in Table 2.3.6-1.

a) Data model: Swath

b) Object Name: **TIR_Band13**

c) Format: The format of each item in Swath object is similar to the one in Table 2.3.6-2.

2.3.6.6 TIR Band 14 Swath

(1) Structure

Refer to the section 2.3.4.2, titled *VNIR Band 1 Swath*.

(2) Characteristics

The contents of TIR Band 14 Swath are similar to the items in Table 2.3.6-1.

a) Data model: Swath

b) Object Name: **TIR_Band14**

c) Format: The format of each item in Swath object is similar to the one in Table 2.3.6-2.

2.3.6.7 TIR Supplement Data

(1) Description

TIR Supplement Data contains TIR status data, calibration data, pointing angles, etc. TIR Supplement Data contains a series of SDS (Temperature, Chopper, and Encoder) through the use of the Vgroup API. vgroup name that establishes access to a Vgroup is as follows.

vgroup name: **TIR_Supplement**
class: **Supplement**

(2) Characteristics

Three categories in Vgroup object are shown as follows.

Supplement Data about Temperature

- a) Data Object: SDS (2 Dimensional Array)
- b) Object Name: **TIR_Supplement_Temp**
- c) Format: Table 2.3.6-3 shows the dimension size and variable type. Table 2.3.6-4 shows the contents of Supplement Data about temperatures with relation to each column of the last dimension.

Table 2.3.6-3 Dimension Size & Variable Type of TIR Supplement Data (Temperature)

Dimension Size	Variable Type
[n][13]	UINT32

**n: revised to accommodate a record count number.
(71: nominal)**

Table 2.3.6-4 Format of TIR Supplement Data (Temperature)

No.*1	Description
0	Time Tag: Spacecraft Time Format
1	
2	Detector Temperature*2
3	
4	
5	
6	
7	Temperature of Chopper*2
8	
9	
10	Temperature of Telescope*2
11	
12	Temperature of Lens*2

NOTES:

(*1) 'No.' expresses the relative position in the last dimension. The dimension is entered in C order ('0' origin).

(*2) Temperature Data consists of two samplings within the each column. Each column is segmented as follows:

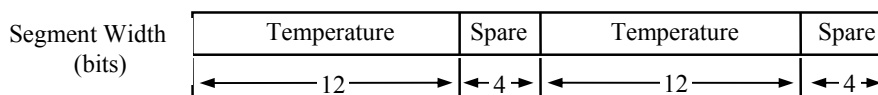

Supplement Data about Chopper

- a) Data Object: SDS (4 Dimensional Array)
- b) Object Name: **TIR_Supplement_Chopper**
- c) Format: Table 2.3.6-5 shows the format and contents of Supplement Data about chopper images.

Table 2.3.6-5 Format of TIR Supplement Data (Chopper*2)

Dimension Size	Variable Type
[n][100][10][8]*1	UINT8

**n: revised to accommodate a processing scene.
(71: nominal)**

NOTES:

- (*1) Chopper image is stored as ‘record * sampling * detector * component’.
- (*2) Each chopper image represents as follows:

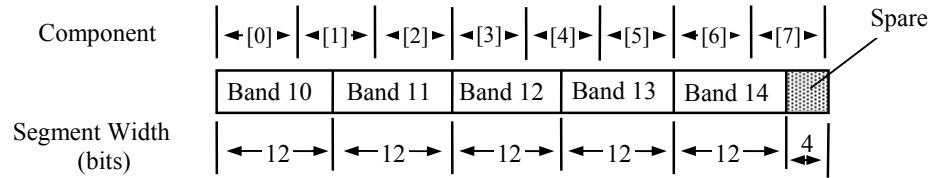

Supplement Data about Encoder

- a) Data Object: SDS (2 Dimensional Array)
- b) Object Name: **TIR_Supplement_Encoder**
- c) Format: Table 2.3.6-6 shows the format and contents of Supplement Data about encoder data.

Table 2.3.6-6 Format of TIR Supplement Data (Encoder)

Dimension Size	Variable Type
[n][935]	UINT16

**n: revised to accommodate a processing scene.
(71: nominal)**

This page intentionally left blank.

3. Level 1B Data Product

3.1 Overview

Level 1B Data Products is an HDF file. Each file contains a complete 1-scene image data generated from Level 1A Data.

All of these data are stored together with Metadata, SDS, Vgroup/Vdata, and Swath Layout parts in one HDF file.

Level 1B Product is created by performing the geometric and radiometric corrections on the original Level 1A image data, and the result is projected onto rotated map (rotated to “path oriented” coordinate) at full instrument resolutions. The Level 1B Data generation includes also scene registrations for SWIR and TIR data. And furthermore for SWIR in particular, the parallax errors due to the spatial locations of all of its bands are also corrected.

Level 1B Data defines a scene center as the geodetic center of the scene obtained from L1A attribute named ‘SceneCenter’ in the HDF-EOS attribute “productmetadata.0”. The definition of scene center in Level 1B is the actual center on the rotated coordinates (L1B coordinates), **not** same as in L1A (i.e., the location on L1B image is between pixels).

Note 1: Resolution is shown as follows.

Subsystem	VNIR	SWIR	TIR
Resolution	15 m	30 m	90 m

Note 2: Saturation Digital Number (DN)

Subsystem	VNIR	SWIR	TIR
DN _{min}	1	1	1
DN _{max}	255	255	4095
dummy pixel	0	0	0

DN_{min} is allocated to zero radiance.

DN_{max} is allocated to the specified maximum radiance for the instrument design.

3.2 Data Structure

(1) Data Type

There are five categories of HDF data type included in Level 1B data product.

Note: VNIR (4 bands) and SWIR (6 bands) image data are 8-bit unsigned integer science data, and TIR (5 bands) image data are 16-bit unsigned integer science data in each category.

(2) Data Structure

The physical data of Level 1B Data Product is shown in Figure 3.2-1. Data structure represented in Figure 3.2-1 shows the conceptual view of the physical format of the product in case of full mode (VST) operation. Some category shall not set in the product, in case that it can not be applied to the dataset on account of the selected operational mode; i.e., V, VB(V stereo), ST, T, etc.

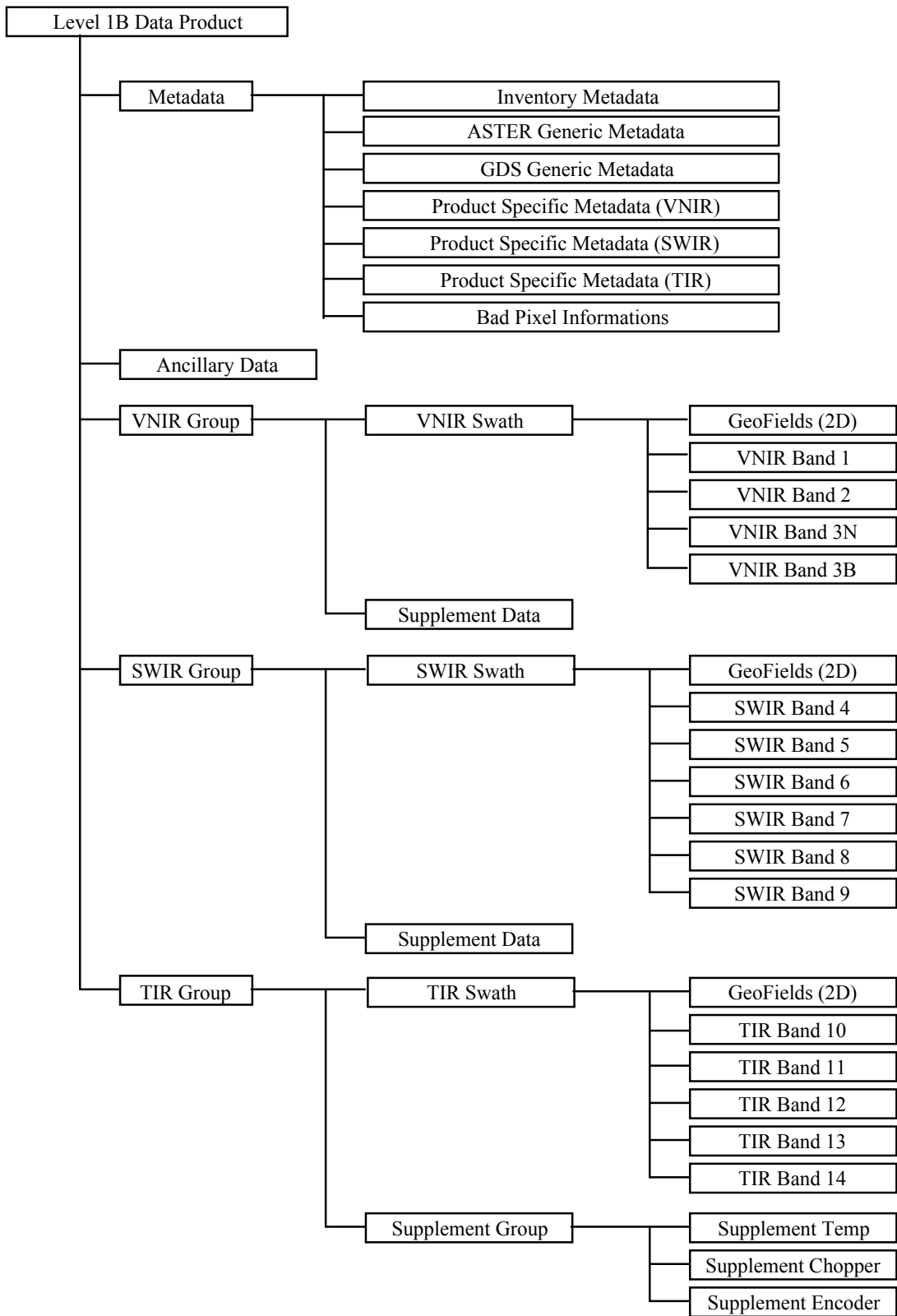

Figure 3.2-1 Physical Data of Level 1B Data Product

3.3 Data Format

3.3.1 Metadata

Level 1B Metadata consists of seven Master Groups, which are named as follows,

- (1) InventoryMetadata
- (2) ASTERGenericMetadata
- (3) GDSGenericMetadata
- (4) ProductSpecificMetadataVNIR :including the attribute about band-1, 2, 3N and 3B data.
- (5) ProductSpecificMetadataSWIR :including the attribute about band-4, 5, 6, 7, 8 and 9 data
- (6) ProductSpecificMetadataTIR :including the attribute about band-10,11, 12, 13 and 14 data.
- (7) BadPixelInformation :including the attribute about lists of bad pixels every band.

3.3.1.1 Inventory Metadata

(1) Indexes of Objects

The object list of Inventory Metadata is shown in Table 3.3.1-1. Inventory Metadata attributes apply to the whole L1B product, and are written to the HDF file attribute named “**coremetadata.0**”.

Inventory Metadata contains ASTER Meta-Parameters in Generic header for ASTER GDS Products (about Generic header for ASTER GDS Products, see ASTER LEVEL 1 DATA PRODUCTS SPECIFICATION -- Applicable [3]). The attributes included in Inventory Metadata are associated with DID311.

(In Table 3.3.1-1, group names are written in **Bold** characters. A group contains a set of objects that all have a similar theme.)

Table 3.3.1-1 List of Objects in Inventory Metadata (1/2)

No.	Group/Object Name	type*1	Description
1	ShortName	string	The short name for information that identifies a dataset: ‘ASTL1B’
2	SizeMBDataGranule	double	The volume of data contained in the granule. Unit: Mbytes
3	ProductionDateTime	datetime	Generation date and time of this Level 1B product.
4	PlatformShortName	string	‘AM-1’ fixed.
5	InstrumentShortName	string	‘ASTER’ fixed.
6	BoundingRectangle		This block contains area coverage for a granule.
	1 WestBoundingCoordinate	double	Western-most coordinate of the scene expressed in longitude.
	2 NorthBoundingCoordinate	double	Northern-most coordinate of the scene expressed in geodetic latitude.
	3 EastBoundingCoordinate	double	Eastern-most coordinate of the scene expressed in longitude.
	4 SouthBoundingCoordinate	double	Southern-most coordinate of the scene expressed in geodetic latitude.
7	SingleDateTime		This contains the time of day and calendar date, at which the center of the scene is observed.
	1 TimeOfDay	string	format: hhmmssd→dZ
	2 CalendarDate	string	format: YYYYMMDD

Table 3.3.1-1 List of Objects in Inventory Metadata (2/2)

No.	Group/Object Name	type*1	Description
8	Review		This block provides for dates and status as applicable for collection that are active.
	1 FutureReviewDate	string	The date of the nearest planned QA peer review in future. format: YYYYMMDD
	2 ScienceReviewDate	string	The date of the last QA peer review. format: YYYYMMDD
9	QAStats		This block contains measures of quality for a granule.
	1 QAPercentMissingData	double	The percentage of missing data in the scene. Unit: %
	2 QAPercentOutOfBoundsData	double	The percentage of out of bounds data in the scene. Unit: %
	3 QAPercentInterpolatedData	double	The percentage of interpolated data in the scene. Unit: %
10	ReprocessingActual	string	The stating what reprocessing has been performed on this granule. {‘not reprocessed’, ‘reprocessed once’, ‘reprocessed twice’, ‘reprocessing n times’}
11	PGEVersion	string	The version of PGE
12	ProcessingLevelID	string	The classification of the science data processing level: ‘1B’
13	MapProjectionName	string	The name of the mapping method for the data. The available map projection methods are as follows: ‘Equi-Rectangular’ , ‘Lambert Conformal Conic’ , ‘Polar Stereographic’ , ‘Space Oblique Mercator’ , and ‘Universal Transverse Mercator’

NOTES:

- (*1) Object types used in Metadata are
 - a. datetime: CCSDS A (UTC) Format
 - b. integer
 - c. double: the floating point value is rounded to the appropriate number (6 digits after the decimal-point character).
 - d. string

3.3.1.2 ASTER Generic Metadata

(1) Indexes of Objects

The Object list of ASTER Generic Metadata is shown in Table 3.3.1-2. ASTER Generic Metadata attributes are written to the HDF file attribute named “**productmetadata.0**”.

ASTER Generic Metadata contains ASTER Parameters in Generic Header for ASTER GDS Products (about Generic header for ASTER GDS Products, see ASTER LEVEL 1 DATA PRODUCTS SPECIFICATION -- Applicable [3]). The ASTER Parameters are ASTER GDS specific attributes, i.e. not associated with DID311.

(In Table 3.3.1-2, group names are written in **Bold** characters. A group contains a set of objects that all have a similar theme.)

Table 3.3.1-2 List of Object in ASTER Generic Metadata (1/5)

No.	Group/Object Name	type* ¹	Description
1	IDofASTERGDSDataGranule	string	This provides a unique identifier for location of a data granule held in ASTER GDS. Format: 'ASTL1B YYMMDDHH MMSSyymmddNNNN' where, YYMMDD:observation date HHMMSS:observation time yymmdd:the data granule generation date NNNN:the data granule sequential No. (per day)
2	ReceivingCenter	string	'EDOS' fixed.
3	ProcessingCenter	string	'ASTER-GDS' fixed.
4	PointingAngles		Specification of the pointing angles of ASTER sensors.
	PointingAnglesContainer(n)* ²		n = number of sensors
	1 SensorName(n)* ²	string	'VNIR' or 'SWIR' or 'TIR'
	2 PointingAngle(n)* ²	double	pointing angle in degrees
3	SettingTimeofPointing(n)* ²	datetime	YYYY-MM-DDThh:mm:ss.d→dZ
5	GainInformation		The information of the gain level.
	GainInformationContainer(n)* ²		This container contains the level of the data acquisition gain for VNIR and SWIR.

Table 3.3.1-2 List of Object in ASTER Generic Metadata (2/5)

No.	Group/Object Name	type*1	Description		
5	1	Gain(n)*2	string	(Band Number, Band Gain) where, Band Number: '01', '02', '3N', '3B', '04', '05', '06', '07', '08', '09' Band Gain: for VNIR: 'HGH': high gain 'NOR': normal gain 'LOW': low gain for SWIR: 'HGH': high gain 'NOR': normal gain 'LO1': low gain 1 'LO2': low gain 2 when data is not acquired or doesn't exist: 'OFF'	
6	CalibrationInformation		Calibration information used to generate the geometric and radiometric correction tables.		
	1	GeometricDBversion	string	The version information of the geometric correction data. (Version, Issuancedate, Comments) where, Version: Version No. Issuance date: Issuance Date Comments: Comments	
	2	RadiometricDBversion	string	The version information of the radiometric correction data. (Version, Issuancedate, Comments) where, Formats of these parameters are the same as Item 6.1.	
	3	CoarseDEMversion*3	string	The version information of the Coarse DEM database. (Version, Issuancedate, Comments) where, Formats of these parameters are the same as Item 6.1.	
7	DataQuality		The information about the quality of this product.		
	1	CloudCoverage	The information about the cloud coverage of the scene		
		1	SceneCloudCoverage	integer	The percentage of cloud coverage for the whole scene. Unit: %

Table 3.3.1-2 List of Object in ASTER Generic Metadata (3/5)

No.			Group/Object Name	type*1	Description
7	1	2	QuadrantCloudCoverage	integer	The percentage for 4 quarters of a scene. (qcul, qcur, qcll, qclr) where, qcul: upper left qcur: upper right qcll: lower left qclr: lower right Unit: %
8			SourceDataProduct	string	The information about the input data used for generating this Level-1B product. (DataID, GenDT, DataTyp) where, DataID: ID of input L1A Data Granule. GenDT: Generation date and time. DataTyp: copy of L1A.
9			InstrumentInformation		The information about sensors used to acquire data.
	1		ASTEROperationMode	string	The types of ASTER operation. 'OBSERVATION' or 'CALIBRATION' or 'TEST'
9	2		ObservationMode		This group contains ASTER observation mode.
			ObservationModeContainer(n) *2		The container of ASTER observation mode.
	1	ASTERObservationMode(n)*2	string	The observation mode of each sensor group. (SGname, Observation) where, SGname: 'VNIR1' or 'VNIR2' or 'SWIR' or 'TIR' Observation: 'ON' (data is acquired) or 'OFF' (data is not acquired, or not existing in the granule)	
	3		ProcessedBands	string	The status of all bands during observation. Format: set of flags described as 2-bytes string. flag = 01,02,3N,3B, ~,14 (data of band 01, 02,3N, ~,14 is used in the granule generation) = XX (data corresponding to the band position marked with XX is not used) Example: Value = 'XXXXXXXXX0405060708091011121314'

Table 3.3.1-2 List of Object in ASTER Generic Metadata (4/5)

No.	Group/Object Name	type*1	Description	
10	SceneInformation		The information about the scene concerning with the data granule.	
	1	ASTERSceneID	integer	The scene identifier defined by path, row and view. (path, row, view) where, path: 1-233 (nominal) row: 1-670 view: 1-7 (-1 for off-nominal pointing)
	2	OrbitNumber*4	integer	The orbit number of the satellite, when data is acquired.
	3	RecurrentCycleNumber*4	integer	The satellite recurrent cycle number and the revolution number in the cycle. (cycle, revolution) where, cycle: 1-260 (max.) revolution: 1-233 (nominal)
	4	FlyingDirection	string	The satellite flight direction when observation is done. 'AS': ascending direction. 'DE': descending direction.
	5	SolarDirection	double	The sun direction as seen from the scene center. (az, el) where, az: azimuth angle in degree. $0.0 \leq az < 360.0$ measured eastward from North. el: elevation angle in degree. $-90.0 \leq el \leq 90.0$
	6	SpatialResolution	integer	The nominal spatial resolutions of VNIR, SWIR and TIR. (resolution of VNIR, resolution of SWIR, resolution of TIR) Unit: meter
	7	SceneFourCorners		This group contains the information about 4 corner coordinates of the scene.
	1	UpperLeft	double	This denotes the coordinates of the upper-left corner of the scene. (lat, long) where, lat: geodetic latitude long: geodetic longitude Unit: degree

Table 3.3.1-2 List of Object in ASTER Generic Metadata (5/5)

No.			Group/Object Name	type*1	Description
10	7	2	UpperRight	double	This denotes the coordinates of the upper-right corner of the scene. (lat, long) where, Formats of these parameters are the same as Item 10.7.1
		3	LowerLeft	double	This denotes the coordinates of the lower-left corner of the scene (lat, long) where, Formats of these parameters are the same as Item 10.7.1
		4	LowerRight	double	This denotes the coordinates of the lower-right corner of the scene. (lat, long) where, Formats of these parameters are the same as Item 10.7.1
	8	SceneCenter	double	Longitude and latitude of the scene center. (lat, long) where, lat: geodetic latitude -90.0≤lat≤90.0 long: East longitude -180.0≤long<180.0 Unit: degree	
	9	MapOrientationAngle	double	This denotes the angle between the path oriented image and the map oriented image within the range [-180.0, 180.0]. Unit: degree	

NOTES:

- (*1) Object types used in Metadata are
 - a. datetime: CCSDS A (UTC) Format
 - b. integer
 - c. double: the floating point value is rounded to the appropriate number (6 digits after the decimal-point character).
 - d. string
- (*2) Object whose name followed by (n) has “class” attribute. It may repeat n-times.
- (*3) Level-1 data product generation software needs GTOPO30 as the source of the ASTER Coarse DEM data.
- (*4) This object is copied from the value denoted in the schedule information that AOS provided.

3.3.1.3 GDS Generic Metadata

(1) Indexes of Objects

The Object list of GDS Generic Metadata is shown in Table 3.3.1-3. GDS Generic Metadata attributes are written to the HDF file named attribute “**productmetadata.1**”.

GDS Generic Metadata contains the generic header specified by GDS for ASTER GDS products. The attributes included in GDS Generic Metadata are the specific attributes, i.e. not associated with DID311 nor the ASTER Parameters.

Table 3.3.1-3 List of Object in GDS Generic Metadata

No.	Object Name	type* ¹	Description
1	SensorShortName	string	The redundant array of short name for all sensors using in generating the product* ² : 'ASTER_VNIR', 'ASTER_SWIR', 'ASTER_TIR', 'ASTER_STEREO'.
2	IDofASTERGDSDataBrowse	string	The ID of ASTER GDS browse granule generated using input Level 1A data product.* ³ .

NOTES:

(*1) Object types used in Metadata are

- a. datetime: CCSDS A (UTC) Format
- b. integer
- c. double: the floating point value is rounded to the appropriate number (6 digits after the decimal-point character).
- d. string

(*2) This item ‘SensorShortName’ contains all available sensor short names.

e.g., for a set of sensors V+S+T: (‘ASTER_VNIR’, ‘ASTER_SWIR’, ‘ASTER_TIR’)
for S+T: (‘ASTER_SWIR’, ‘ASTER_TIR’)

(*3) This item is carried from L-1A information (L-1B browse is not created, and so refer to L-1A browse product as L-1B browse image.).

3.3.1.4 Product Specific Metadata(VNIR)

(1) Indexes of Objects

The Object list of Product Specific Metadata(VNIR) is shown in Table 3.3.1-4. Product Specific Metadata(VNIR) attributes are written to the HDF file attribute named “**productmetadata.v**”.

Product Specific Metadata(VNIR) includes product specific attributes, i.e. not associated with DID311.

(In Table 3.3.1-4, group names are written in **Bold** characters. A group contains a set of objects that all have a similar theme.)

Table 3.3.1-4 List of Object in Level 1B Product Specific Metadata(VNIR) (1/2)

No.	Group/Object Name	type*1	Description
1	VNIRBand1Data		The information about VNIR band 1 of Level-1B
1	ImageDataInformation1	integer	The information of VNIR band 1 image data. (npx, nln, bpp) where, npx: Number of pixels per line (4980: nominal) nln: Number of lines in frame (4200: nominal) bpp: Bytes per pixel (1: fixed)
2	ImageStatistics1		The statistical information about the quality of Level 1B VNIR band 1 data.
1	MinandMax1	integer	Minimum and Maximum value in this band of Level 1B VNIR image data. (min, max) where, min: Minimum value ($1 \leq \min \leq 255$) max: Maximum value ($1 \leq \max \leq 255$)
2	MeanandStd1	double	Mean and Standard deviation value in this band of Level 1B VNIR image data. (mean, sd) where, mean: Mean value ($1.0 \leq \text{mean} \leq 255.0$) sd: Standard deviation value
3	ModeandMedian1	integer	Mode and Median value in this band of Level 1B VNIR image data. (mode, med) where, mode: Mode value ($1 \leq \text{mode} \leq 255$) med: Median value ($1 \leq \text{med} \leq 255$)
3	DataQuality1		This group contains the information about the quality of Level 1B band 1 VNIR data.

Table 3.3.1-4 List of Object in Level 1B Product Specific Metadata(VNIR) (2/2)

No.		Group/Object Name	type*1	Description	
1	3	1	integer	The number of bad pixels in the L-1B VNIR band-1 image. (nbp, ncg) where, nbp: number of bad pixels. ncg: number of elements of the list of bad pixels*3.	
		ProcessingParameters1		This group contains the parameters used by Level-1B generation processing.	
	4	1	CorIntel1	string	Correction of the intertelescope error of SWIR and TIR: 'N/A' fixed.
		2	CorPara1	string	Correction of the SWIR parallax error: 'N/A' fixed.
		3	ResMethod1	string	Resampling Method: 'BL' or 'NN' or 'CC'
		4	MPMethod1	string	Map Projection Method: 'UTM', 'PS', 'LAMCC', 'SOM', or 'EQRECT'
		5	ProjectionParameters1	double	Parameters used in GCTP Map projection. (when parameters that are not used are filled with the value "0.0".)
		6	UTMZoneCode1	integer	Zone code for UTM projection (when mapping without UTM.: 0 fixed). If southern zone is intended then use negative values.
	5	UnitConversionCoeff1			This group contains the coefficients used for radiance conversion, from the pixel value of the band-1 image.
		1	Incl1	double	Inclination Value
		2	Offset1	double	Offset Value
		3	ConUnit1	string	Converted Unit 'W/m ² /sr/μm' fixed.
	2 ~ 2.5.3		For next VNIRBand2Data , repeat the above items (1 through 1.5.3).		
3 ~ 3.5.3		For next VNIRBand3NData , repeat the above items (1 through 1.5.3).			
4 ~ 4.5.3		For next VNIRBand3BData , repeat the above items (1 through 1.5.3).			

NOTES:

- (*1) Object types used in Metadata are
 - a. datetime: CCSDS A (UTC) Format
 - b. integer
 - c. double: the floating point value is rounded to the appropriate number (6 digits after the decimal-point character).
 - d. string
- (*2) Object whose name followed by (n) has "class" attribute. It may repeat n-times.
- (*3) The information concerning the list of bad pixels apart from this attribute and is written to the separated attribute named "badpixelinformation". Refer to the section 3.3.1.7, titled *Bad Pixel Information*.
- (*4) Level 1B image is projected onto map using GCTP map projection tools through SCF Toolkit. About the parameters used in GCTP, see Appendix G of SCF Toolkit Users Guide (reference [8]).

3.3.1.5 Product Specific Metadata(SWIR)

(1) Indexes of Objects

The Object list of Product Specific Metadata(SWIR) is shown in Table 3.3.1-5. Product Specific Metadata(SWIR) attributes are written to the HDF file attribute named “**productmetadata.s**”.

Product Specific Metadata(SWIR) includes product specific attributes, i.e. not associated with DID311. (In Table 3.3.1-5, group names are written in **Bold** characters. A group contains a set of objects that all have a similar theme.)

Table 3.3.1-5 List of Object in Level 1B Product Specific Metadata(SWIR) (1/3)

No.	Group/Object Name	type*1	Description
1	SWIRBand4Data		The information about SWIR band 4 of Level-1B.
1	ImageDataInformation4	integer	The information of SWIR band 4 image data. (npx, nln, bpp) where, npx: Number of pixels per line (2490: nominal) nln: Number of lines in frame (2100: nominal) bpp: Bytes per pixel (1: fixed)
2	ImageStatistics4		The statistical information about the quality of Level 1B SWIR band 4 data.
1	MinandMax4	integer	Minimum and Maximum value in this band of Level 1B SWIR image data. (min, max) where, min: Minimum value ($1 \leq \text{min} \leq 255$) max: Maximum value ($1 \leq \text{max} \leq 255$)
2	MeanandStd4	double	Mean and Standard deviation value in this band of Level 1B SWIR image data. (mean, sd) where, mean: Mean value ($1.0 \leq \text{mean} \leq 255.0$) sd: Standard deviation value
3	ModeandMedian4	integer	Mode and Median value in this band of Level 1B SWIR image data. (mode, med) where, mode: Mode value ($1 \leq \text{mode} \leq 255$) med: Median value ($1 \leq \text{med} \leq 255$)
3	DataQuality4		This group contains the information about the quality of Level 1B SWIR data.

Table 3.3.1-5 List of Object in Level 1B Product Specific Metadata(SWIR) (2/3)

No.	Group/Object Name	type*1	Description
1	3	1	NumberofBadPixels4 integer The number of bad pixels in the L-1B SWIR band-4 image. (nbp, ncg) where, nbp: number of bad pixels. ncg: number of elements of the list of bad pixels*3.
		2	SWIRRegistrationQuality4 The registration information of SWIR based on VNIR.
	1	1	ProcessingFlag4 integer Processing flag: 0: no output, because processing is impossible. 1: output is the result computed. 2: output is extracted from registration file. 4: output obtained by other method.
		2	NumberofMeasurements4 integer The number of measurements
		3	MeasurementPointNumber4 integer The number of measurement points.
		4	AverageOffset4 double Average offset value. (LAOset, PAOset) where, LAOset: average offset in along track direction. PAOset: average offset in cross track direction.
		5	StandardDeviationOffset4 double Standard deviation offset value. (LSDOset, PSDOset) where, LSDOset: SD offset in along track direction. PSDOset: SD offset in cross track direction.
		6	Threshold4 double Threshold value. (CThld, LOThld, POThld, VOThld) where, CThld: Correction threshold LOThld: offset threshold in along track direction POThld: offset threshold in cross track direction VOThld: Vector offset threshold
	3	ParallaxCorrectionQuality4 The information of SWIR parallax correction.	
		1	PctImageMatch4 integer The percentage of image matching used in the SWIR parallax correction processing. Unit: %
		2	AvgCorrelCoef4 double The Average Correlation Coefficient.

Table 3.3.1-5 List of Object in Level 1B Product Specific Metadata(SWIR) (3/3)

No.	Group/Object Name	type*1	Description	
1	3 3 3	Cthld4	double	The Correlation Threshold value.
	4	ProcessingParameters4		This group contains the parameters used by Level-1B generation processing.
	1	CorIntel4	string	Correction of the intertelescope error of SWIR and TIR: 'Corrected Intertelescope Error' or 'Uncorrected Intertelescope Error'
	2	CorPara4	string	Correction of the SWIR parallax error: 'Corrected Parallax Error' or 'Uncorrected Parallax Error'
	3	ResMethod4	string	Resampling Method: 'BL' or 'NN' or 'CC'
	4	MPMethod4	string	Map Projection Method: 'UTM', 'PS', 'LAMCC', 'SOM', or 'EQRECT'
	5	ProjectionParameters4	double	Parameters used in GCTP Map projection. (when parameters that are not used are filled with the value "0.0".)
	6	UTMZoneCode4	integer	Zone code for UTM projection (when mapping without UTM.: 0 fixed). If southern zone is intended then use negative values.
	5	UnitConversionCoeff4		This group contains the coefficients used for radiance conversion, from the pixel value of the band-4 image.
	1	Incl4	double	Inclination Value
	2	Offset4	double	Offset Value
	3	ConUnit4	string	Converted Unit 'W/m ² /sr/μm' fixed.
2 ~ 2.5.3		For next SWIRBand4Data , repeat the above items (1 through 1.5.3).		
3 ~ 3.5.3		For next SWIRBand5Data , repeat the above items (1 through 1.5.3).		
4 ~ 4.5.3		For next SWIRBand6Data , repeat the above items (1 through 1.5.3).		
5 ~ 5.5.3		For next SWIRBand7Data , repeat the above items (1 through 1.5.3).		
6 ~ 6.5.3		For next SWIRBand8Data , repeat the above items (1 through 1.5.3).		

NOTES:

- (*1) Object types used in Metadata are
 - a. datetime: CCSDS A (UTC) Format
 - b. integer
 - c. double: the floating point value is rounded to the appropriate number (6 digits after the decimal-point character).
 - d. string
- (*2) Object whose name followed by (n) has "class" attribute, it may repeat n-times.
- (*3) The information concerning the list of bad pixels apart from this attribute and is written to the separated attribute named "badpixelinformation". Refer to the section 3.3.1.7, titled *Bad Pixel Information*.
- (*4) Level 1B image is projected onto map using GCTP map projection tools through SCF Toolkit. About the parameters used in GCTP, see Appendix G of SCF Toolkit Users Guide (reference [8]).

3.3.1.6 Product Specific Metadata(TIR)

(1) Indexes of Objects

The Object list of Product Specific Metadata(TIR) is shown in Table 3.3.1-6. Product Specific Metadata(TIR) attributes are written to the HDF file attribute named “**productmetadata.t**”.

Product Specific Metadata(TIR) includes product specific attributes, i.e. not associated with DID311.

(In Table 3.3.1-6, group names are written in **Bold** characters. A group contains a set of objects that all have a similar theme.)

Table 3.3.1-6 List of Object in Level 1B Product Specific Metadata(TIR) (1/3)

No.	Group/Object Name	type*1	Description
1	TIRBand10Data		The information about TIR band 10 of Level-1B.
1	ImageDataInformation10	integer	The information of TIR band 10 image data. (npx, nln, bpp) where, npx: Number of pixels per line (830: nominal) nln: Number of lines in frame (700: nominal) bpp: Bytes per pixel (2: fixed)
2	ImageStatistics10		The statistical information about the quality of Level 1B TIR data.
1	MinandMax10	integer	Minimum and Maximum value in this band of Level 1B TIR image data. (min, max) where, min: Minimum value $(1 \leq \text{min} \leq 4095)$ max: Maximum value $(1 \leq \text{max} \leq 4095)$
2	MeanandStd10	double	Mean and Standard deviation value in this band of Level 1B TIR image data. (mean, sd) where, mean: Mean value $(1.0 \leq \text{mean} \leq 4095.0)$ sd: Standard deviation value
3	ModeandMedian10	integer	Mode and Median value in this band of Level 1B TIR image data. (mode, med) where, mode: Mode value $(1 \leq \text{mode} \leq 4095)$ med: Median value $(1 \leq \text{med} \leq 4095)$
3	DataQuality10		This group contains the information about the quality of Level 1B TIR data.

Table 3.3.1-6 List of Object in Level 1B Product Specific Metadata(TIR) (2/3)

No.	Group/Object Name	type*1	Description
1	3	1	NumberofBadPixels10 integer The number of bad pixels in the L-1B TIR band-10 image. (nbp, ncg) where, nbp: number of bad pixels. ncg: number of elements of the list of bad pixels*3.
		2	TIRRegistrationQuality10 The registration information of TIR based on VNIR.
	1	1	ProcessingFlag10 integer Processing flag: 0: no output, because processing is impossible. 1: output is the result computed. 2: output is extracted from registration file. 4: output obtained by other method.
		2	NumberofMeasurements10 integer The number of measurements
		3	MeasurementPointNumber10 integer The number of measurement points.
		4	AverageOffset10 double Average offset value. (LAOset, PAOset) where, LAOset: average offset in along track direction. PAOset: average offset in cross track direction.
		5	StandardDeviationOffset10 double Standard deviation offset value. (LSDOset, PSDOset) where, LSDOset: SD offset in along track direction. PSDOset: SD offset in cross track direction.
		6	Threshold10 double Threshold value. (CThld, LOThld, POThld, VOThld) where, CThld: Correction threshold LOThld: offset threshold in along track direction POThld: offset threshold in cross track direction VOThld: Vector offset threshold
	4	ProcessingParameters10 This group contains the parameters used by Level-1B generation processing.	
	1	CorIntel10 string Correction of the intertelescope error of SWIR and TIR: 'Corrected Intertelescope Error' or 'Uncorrected Intertelescope Error'	

Table 3.3.1-6 List of Object in Level 1B Product Specific Metadata(TIR) (3/3)

No.	Group/Object Name	type*1	Description		
1	4	2	CorPara10	string	Correction of the SWIR parallax error: 'N/A' fixed.
		3	ResMethod10	string	Resampling Method: 'BL' or 'NN' or 'CC'
		4	MPMethod10	string	Map Projection Method: 'UTM', 'PS', 'LAMCC', 'SOM', or 'EQUIRECT'
		5	ProjectionParameters10	double	Parameters used in GCTP Map projection. (when parameters that are not used are filled with the value "0.0".)
		6	UTMZoneCode10	integer	Zone code for UTM projection (when mapping without UTM.: 0 fixed). If southern zone is intended then use negative values.
		5	UnitConversionCoeff10		This group contains the coefficients used for radiance conversion, from the pixel value of the band-10 image.
		1	Incl10	double	Inclination Value
		2	Offset10	double	Offset Value
		3	ConUnit10	string	Converted Unit 'W/m ² /sr/μm' fixed.
2 ~ 2.5.3	For next TIRBand11Data , repeat the above items (1 through 1.5.3).				
3 ~ 3.5.3	For next TIRBand12Data , repeat the above items (1 through 1.5.3).				
4 ~ 4.5.3	For next TIRBand13Data , repeat the above items (1 through 1.5.3).				
5 ~ 5.5.3	For next TIRBand14Data , repeat the above items (1 through 1.5.3).				

NOTES:

- (*1) Object types used in Metadata are
 - a. datetime: CCSDS A (UTC) Format
 - b. integer
 - c. double: the floating point value is rounded to the appropriate number (6 digits after the decimal-point character).
 - d. string
- (*2) Object whose name followed by (n) has "class" attribute, it may repeat n-times.
- (*3) The information concerning the list of bad pixels apart from this attribute and is written to the separated attribute named "badpixelinformation". Refer to the section 3.3.1.7, titled *Bad Pixel Information*.
- (*4) Level 1B image is projected onto map using GCTP map projection tools through SCF Toolkit. About the parameters used in GCTP, see Appendix G of SCF Toolkit Users Guide (reference [8]).

3.3.1.7 Bad Pixel Information

(1) Indexes of Objects

The Object list of Bad Pixel Information is shown in Table 3.3.1-7. Bad Pixel Information attributes are written to the HDF file attribute named “**badpixelinformation**”.

Bad Pixel Information includes product specific attributes, i.e. not associated with DID311.

(In Table 3.3.1-7, group names are written in **Bold** characters. A group contains a set of objects that all have a similar theme.)

Bad Pixel information is set for every band individually, and the mandatory attributes for their objects are flagged as “FALSE”. No group that has no bad pixel, namely, is set in this attribute. So, in case that all bands have no bad pixel, this specific attribute will not appear in the HDF-EOS attribute.

Table 3.3.1-7 List of Object in Bad Pixel Information (1/2)

No.	Group/Object Name	type* ¹	Description
1	Band1Information		This group contains the information concerning bad (interpolated) pixel of Level 1B VNIR Band-1 image.
1	NumberofElement1	integer	The number of elements of the list of bad pixels
2	ListofBadPixels1		This group contains the locations of bad pixels.
	ListofBadPixels1Container(n) ^{*2}		
1	BadPixelSegments1(n) ^{*2}	integer	Location information for each bad pixel element. (Lno, FP, LP) where, Lno: The line number including bad pixel segment FP: First pixel number of BPS LP: Last pixel number of BPS
2 ~ 2.2.1	For next Band2Information , repeat the above items (1 through 1.2.1).		
3 ~ 3.2.1	For next Band3NInformation , repeat the above items (1 through 1.2.1).		
4 ~ 4.2.1	For next Band3BInformation , repeat the above items (1 through 1.2.1).		
5 ~ 5.2.1	For next Band4Information , repeat the above items (1 through 1.2.1).		
6 ~ 6.2.1	For next Band5Information , repeat the above items (1 through 1.2.1).		
7 ~ 7.2.1	For next Band6Information , repeat the above items (1 through 1.2.1).		
8 ~ 8.2.1	For next Band7Information , repeat the above items (1 through 1.2.1).		
9 ~ 9.2.1	For next Band8Information , repeat the above items (1 through 1.2.1).		
10 ~ 10.2.1	For next Band9Information , repeat the above items (1 through 1.2.1).		

Table 3.3.1-7 List of Object in Bad Pixel Information (2/2)

No.	Group/Object Name	type*1	Description
11 ~ 11.2.1	For next Band10Information ,		repeat the above items (1 through 1.2.1).
12 ~ 12.2.1	For next Band11Information ,		repeat the above items (1 through 1.2.1).
13 ~ 13.2.1	For next Band12Information ,		repeat the above items (1 through 1.2.1).
14 ~ 14.2.1	For next Band13Information ,		repeat the above items (1 through 1.2.1).
15 ~ 15.2.1	For next Band14Information ,		repeat the above items (1 through 1.2.1).

NOTES:

(*1) Object types used in Metadata are

- a. datetime: CCSDS A (UTC) Format
- b. integer
- c. double: the floating point value is rounded to the appropriate number
(6 digits after the decimal-point character).
- d. string

(*2) Object whose name followed by (n) has “class” attribute. It may repeat n-times.

3.3.2 Ancillary Data

(1) Description

Ancillary Data includes the satellite's orbit/attitude data, and their time tags. Since ancillary data appended to onboard instrument data are updated once per major cycle time (1.024 sec), in order to match with the scene observation time, an extra number of ancillary data will be extracted and provided. To ensure the conformity with instrument data, the time data which represents the ancillary data updating time(UTC) is assigned to the leading ancillary data, and called Time Tag. This is used as control data for extracted Image Data.

(2) Characteristics

Ancillary Data Group contains a series of Ancillary Data Records through the use of Vgroup API.

vgroup name: **Ancillary_Data**
class: **Ancillary**

Each record of Ancillary Data has following characteristics.

- a) Data model: Vdata
- b) Object Name: **Ancillary_Data**
- c) Class Name: Anc_Record.*n* (*n*: Record count number -- 12 ~ 29 records)
- d) Format and contents: see Table 2.3.3-1.

3.3.3 VNIR Group

3.3.3.1 Overview

VNIR Group contains an SDS and a Swath Object through the use of the Vgroup API. Vgroup name that establishes access to a Vgroup is as follows.

vgroup name: **VNIR**
class: **1B**

(1) Concept of Level 1B Data Product

The Level 1B Data Product is generated for the requested map projection and the resampling method, which for this release is:

Map projection methods: Geographic (**EQRECT**), Lambert Conformal Conic (**LAMCC**), Polar Stereographic (**PS**), Space Oblique Mercator (**SOM**), and Universal Transverse Mercator (**UTM**)

Resampling methods: Nearest Neighbor (**NN**), Bi-Linear (**BL**), Cubic Convolution (**CC**)

For further details on projection parameters (Projection Codes, Zone Codes, and so on), please refer to the HDF-EOS User's Guide for ECS Project (Reference [4]) and the SDP Toolkit Users Guide for the ECS Project (Reference [8]).

3.3.3.2 VNIR Swath

(1) Structure

A single swath contains any number of Tables and Multidimensional Arrays. There is however one type of information that is special: geolocation information. In a swath, geolocation information is stored as a series of arrays. We require that every swath contain some geolocation component. The data itself is stored in multidimensional arrays in the swath. The only limitation is that the first dimension is the Track dimension.

For the Level 1B Data Product, all bands in the same telescope are stored as a data field of the swath created per telescope, and share the same geolocation information. The structure of each Swath is almost as same as the Level 1A Swath (see Figure 2.3.4-1), though the Level 1B swath consists of a series of 2D data array (VNIR image data: Band 1, 2, 3N, 3B) and a 2D geolocation arrays only.

(2) Characteristics

Table 3.3.3-1 shows the List of data items in VNIR Swath (Swath data for VNIR).

a) Data model: Swath

b) Object Name: **VNIR_Swath**

c) Format: Table 3.3.3-1 shows the contents of Swath Object. Table 3.3.3-2 shows the format of one.

Table 3.3.3-1 List of data items in Level 1B VNIR Swath

No.	Field Name	Type	Unit	Comments
1.	Latitude	Geolocation Array	deg.	geocentric latitude: decimal degree on range [-90.0, 90.0]
2.	Longitude	Geolocation Array	deg.	geocentric longitude: decimal degree on range [-180.0, 180.0)
3.	ImageData1	2D Data Array	N/A	Level 1B spectral band 1 image data
4.	ImageData2	2D Data Array	N/A	Level 1B spectral band 2 image data
5.	ImageData3N	2D Data Array	N/A	Level 1B spectral band 3N image data
6.	ImageData3B	2D Data Array	N/A	Level 1B spectral band 3B image data

Table 3.3.3-2 Format of data items in VNIR Swath

Field Name	Dimension Size	Variable Type	Remarks
Latitude	[11][11]	DOUBLE	geolocation field (Array)
Longitude	[11][11]	DOUBLE	geolocation field (Array)
ImageData1	[4200][4980]	UINT8	mapping to geolocation array
ImageData2	[4200][4980]	UINT8	mapping to geolocation array
ImageData3N	[4200][4980]	UINT8	mapping to geolocation array
ImageData3B	[4600][4980]	UINT8	mapping to geolocation array

(3) Block Size

Block size is shown as follows.

Type	Block size
Geolocation Array	420 lines * 498 pixels

3.3.3.3 VNIR Supplement Data

(1) Description

VNIR Supplement Data contains VNIR status data, calibration data, pointing angles, etc.

(2) Characteristics

a) Data model: SDS (2 Dimensional Array)

b) Object Name: **VNIR_Supplement**

c) Format: see the section 2.3.4.6, titled *VNIR Supplement Data*.

3.3.4 SWIR Group

3.3.4.1 Overview

SWIR Group contains an SDS and a Swath Object through the use of the Vgroup API. Vgroup name that establishes access to a Vgroup is as follows.

vgroup name: **SWIR**
class: **1B**

3.3.4.2 SWIR Swath

(1) Structure

Refer to the section 3.3.3.2, titled *VNIR Swath*.

(2) Characteristics

Table 3.3.4-1 shows the List of data items in SWIR Swath (Swath data for SWIR).

a) Data model: Swath

b) Object Name: **SWIR_Swath**

c) Format: Table 3.3.4-1 shows the contents of Swath Object. Table 3.3.4-2 shows the format of one.

Table 3.3.4-1 List of data items in Level 1B SWIR Swath

No.	Field Name	Type	Unit	Comments
1.	Latitude	Geolocation Array	deg.	geocentric latitude: decimal degree on range [-90.0, 90.0]
2.	Longitude	Geolocation Array	deg.	geocentric longitude: decimal degree on range [-180.0, 180.0)
3.	ImageData4	2D Data Array	N/A	Level 1B spectral band 4 image data
4.	ImageData5	2D Data Array	N/A	Level 1B spectral band 5 image data
5.	ImageData6	2D Data Array	N/A	Level 1B spectral band 6 image data
6.	ImageData7	2D Data Array	N/A	Level 1B spectral band 7 image data
7.	ImageData8	2D Data Array	N/A	Level 1B spectral band 8 image data
8.	ImageData9	2D Data Array	N/A	Level 1B spectral band 9 image data

Table 3.3.4-2 Format of data items in SWIR Swath

Field Name	Dimension Size	Variable Type	Remarks
Latitude	[11][11]	DOUBLE	geolocation field (Array)
Longitude	[11][11]	DOUBLE	geolocation field (Array)
ImageData4	[2100][2490]	UINT8	mapping to geolocation array
ImageData5	[2100][2490]	UINT8	mapping to geolocation array
ImageData6	[2100][2490]	UINT8	mapping to geolocation array
ImageData7	[2100][2490]	UINT8	mapping to geolocation array
ImageData8	[2100][2490]	UINT8	mapping to geolocation array
ImageData9	[2100][2490]	UINT8	mapping to geolocation array

(3) Block Size

Block size is shown as follows.

Type	Block size
Geolocation Array	210 lines * 249 pixels

3.3.4.3 SWIR Supplement Data

(1) Description

SWIR Supplement Data contains SWIR status data, calibration data, pointing angles, etc.

(2) Characteristics

a) Data Model: SDS (2 Dimensional Array)

b) Object Name: **SWIR_Supplement**

c) Format: see the section 2.3.5.8, titled *SWIR Supplement Data*.

3.3.5 TIR Group

3.3.5.1 Overview

TIR Group contains a Vgroup and a Swath Object through the use of the Vgroup API. Vgroup name that establishes access to a Vgroup is as follows.

vgroup name: **TIR**
class: **1B**

3.3.5.2 TIR Swath

(1) Structure

Refer to the section 3.3.3.2, titled *VNIR Swath*.

(2) Characteristics

Table 3.3.5-1 shows the List of data items in TIR Swath (Swath data for TIR).

a) Data model: Swath

b) Object Name: **TIR_Swath**

c) Format: Table 3.3.5-1 shows the contents of Swath Object. Table 3.3.5-2 shows the format of one.

Table 3.3.5-1 List of data items in Level 1B TIR Swath

No.	Field Name	Type	Unit	Comments
1.	Latitude	Geolocation Array	deg.	geocentric latitude: decimal degree on range [-90.0, 90.0]
2.	Longitude	Geolocation Array	deg.	geocentric longitude: decimal degree on range [-180.0, 180.0)
3.	ImageData10	2D Data Array	N/A	Level 1B spectral band 10 image data
4.	ImageData11	2D Data Array	N/A	Level 1B spectral band 11 image data
5.	ImageData12	2D Data Array	N/A	Level 1B spectral band 12 image data
6.	ImageData13	2D Data Array	N/A	Level 1B spectral band 13 image data
7.	ImageData14	2D Data Array	N/A	Level 1B spectral band 14 image data

Table 3.3.5-2 Format of data items in TIR Swath

Field Name	Dimension Size	Variable Type	Remarks
Latitude	[11][11]	DOUBLE	geolocation field (Array)
Longitude	[11][11]	DOUBLE	geolocation field (Array)
ImageData10	[700][830]	UINT16	mapping to geolocation array
ImageData11	[700][830]	UINT16	mapping to geolocation array
ImageData12	[700][830]	UINT16	mapping to geolocation array
ImageData13	[700][830]	UINT16	mapping to geolocation array
ImageData14	[700][830]	UINT16	mapping to geolocation array

(3) Block Size

Block size is shown as follows.

Type	Block size
Geolocation Array	70 lines * 83 pixels

3.3.5.3 TIR Supplement Data

(1) Description

TIR Supplement Data contains TIR status data, calibration data, pointing angles, etc.

TIR Supplement Data contains a series of SDS (Temperature, Chopper, and Encoder) through the use of the Vgroup API. vgroup name that establishes access to a Vgroup is as follows.

vgroup name: **TIR_Supplement**
class: **Supplement**

(2) Characteristics

See the section 2.3.6.7, titled *TIR Supplement Data*.

Appendix A. Programming Model

A.1 Overview

This Section contains programming model for accessing Level 1A and 1B Data Products by the Swath API.

The reader is directed to The HDF-EOS User's Guide for the ECS Project (Reference [4]), Sections 7 and 8, for further detailed references.

A.2 Swath

The programming model for accessing a swath data set through the SW interface is as follows:

1. Open the file and initialize the SW interface by obtaining a file ID from a file name.
2. Open a swath data set by obtaining a swath ID from a swath name.
3. Perform desired operations on data set.
4. Close the swath data set by disposing of swath ID.
5. Terminate swath access to the file by disposing of the file ID.

To access a single swath data set in Level 1A Data Product (HDF file), the calling program must contain the following sequence of C calls:

```
file_id = SWopen(filename, DFACC_READ) ;
```

```
sw_id = SWattach(file_id, swath_name) ;
```

<Optional operations>

inquiry or subset or read by using function as follows:

```
SWnentries(sw_id, entry_code, string_buffer_size) ;
```

```
SWinqgeofields(sw_id, field_list, rank, number_type) ;
```

```
SWinqdatafields(sw_id, field_list, rank, number_type) ;
```

```
SWfieldinfo(sw_id, field_name, rank, dims, number_type, dim_list) ;
```

```
SWreadfield(sw_id, field_name, start, stride, edge, buffer) ;
```

```
SWdefboxregion(sw_id, corner_lon, corner_lat, mode) ;
```

```
SWextractregion(region_id, field_name, external_made, buffer) ;
```

```
status = SWdetach(sw_id) ;
```

```
status = SWclose(file_id) ;
```

Abbreviations and Acronyms

A

AOS: ASTER Operations Segment
API: Application Program Interface
APID: Application Process IDentifier
ASCII: American Standard Code for Information Interchange
ASTER: Advanced Spaceborne Thermal Emission and Reflection Radiometer (formerly ITIR)
ATBD: Algorithm Theoretical Basis Document

B

BL: Bi-Linear
BPS: Bad Pixel Segment

C

CC: Cubic Convolution
CCSDS: Consultative Committee on Space Data System
CDRL: Construct Data Requirement List
CDS: CCSDS Day Segmented Time Code
COTS: commercial off-the-shelf
CSCI: Computer Software Configuration Item

D

DAAC: Distributed Active Archive Center
DDL: Direct Down Link
DDS: DDL Data Set
DEM: Digital Elevation Model
DID: Data Item Description
DID311: 311-CD-002-005, Science Data Processing Segment (SDPS) Database Design and Database Schema Specifications for the ECS Project, May 1996 (Reference [9])
DOUBLE: double type (IEEE Double-Precision Format)
DPS: Data Processing Subsystem

E

ECEF: Earth Centered, Earth Fixed
ECI: Earth centered inertial
ECR: Earth centered rotating
ECS: EOSDIS Core System
EDC: EROS Data Center (DAAC)
EDS: Expedited Data Set
EDOS: EOSDIS Data and Operation System
EOS: Earth Observing System
EOSDIS: Earth Observing System Data and Information System
EQRECT: Equi-Rectangular (Geographic, Uniform Longitude/Latitude)
EROS: Earth Resource Observation System
ERSDAC: Earth Remote Sensing Data Analysis Center
ESDIS: Earth Science Data and Information System
eom: End of month

F

FLOAT: float type (IEEE Single-Precision Format)

G

GCT: geo-coordinate transformation

GCTP: General Cartographic Transformation Package
GDS: Ground Data System
GMT: Greenwich Mean Time
GSFC: Goddard Space Flight Center
GTOPO30: Global Topographic 30-arc-seconds DEM

H

HDF: Hierarchical Data Format
HDF-EOS: an EOS proposed standard for a specialized HDF data format
HITC: Hughes Information Technology Corporation

I

I/F: interface
I/O: input/output
ICD: Interface Control Document
ID: IDentification
IEEE: Institute of Electrical and Electronics Engineers
IERS: International Earth Rotation Service
IMS: Information Management System
INT8: 8-bit integer type
INT16: 16-bit integer type
INT32: 32-bit integer type
INT64: 64-bit integer type
IR: Interim Release
ISO: International Standards Organization

J

JD: Julian Day
JPL: Jet Propulsion Laboratory

L

LAMCC: Lambert Conformal Conic

M

MCF: Metadata Configuration File
MJD: Modified Julian Day

N

N/A: Not Applicable
NASA: National Aeronautics and Space Administration
NCSA: the National Center for Supercomputing Applications
NN: Nearest Neighbor

O

OBS: Observation
ODL: Object Description Language

P

PDS: Production Data Set
PGE: Product Generation Executive
PGS: Product Generation System
PGSTK: Product Generation System Toolkit
POSIX: Portable Operating System Interface for Computer Environments
PS: Polar Stereographic
PVL: Parameter Value Language

Q

QA: Quality Assurance

R

RIS8: 8-bit Raster type
RIS24: 24-bit Raster type
RMS: Root Mean Squared
RTF: Rich Text Format

S

SCF: Science Computing Facility
SDP: Science Data Production
SDTS: Spacial Data Transfer Standard
SDPS: Science Data Processing Segment
SDPS/W: Science Data Processing Software
SDPTK: SDP Toolkit CSCI
SGI: Silicon Graphics Incorporated
SOM: Space Oblique Mercator
SW: Swath
SWIR: Shortwave Infrared

T

TAI: International Atomic Time
TBD: To Be Determined
TBR: To Be Resolved
TBS: To Be Specified
TIR: Thermal Infrared

U

U.S.: United States
UINT8: 8-bit unsigned integer type.
UINT16: 16-bit unsigned integer type.
UINT32: 32-bit unsigned integer type
UINT64: 64-bit unsigned integer type
UT: Universal Time
UTC: Universal Time Coordinated
UTM: Universal Transverse Mercator

V

VNIR: Visible and Near Infrared

W

WGS84: World Geometric System '84